



## User Instruction & Installation Manual

### LX230 100 Watt 12/24/240v H.I.D Xenon Searchlight



#### Product Reference Number:

**A6083/A6104 – LX230 Deck**  
**A6085/A6106 – LX230 DP**

**A6084/A6105 - LX230 Cabin**  
**A6086/A6107 - LX230 CP**

#### *Manufacturer's details:*

Francis Searchlights Ltd  
Union Road, Bolton  
Lancashire, BL2 2HJ, UK  
Tel: +44 (0) 1204 558960  
Fax: +44 (0) 1204 558979  
<http://www.francis.co.uk>  
E-mail: [sales@francis.co.uk](mailto:sales@francis.co.uk)

#### *Distributor details:*

Manual Part Number: **C25889**

Issue: 3

12.3.14

# CONTENTS

- 1 - Introduction
- 2 - Safety Precautions
- 3 - Technical Information
- 4 - Unpacking and Installation Instructions
- 5 - Electrical Installation
- 6 - Operating Instructions
- 7 - Fault Finding
- 8 - Maintenance and Servicing
- 9 - General Assembly and Wiring Diagrams
- 10 - Spare Parts List

## 1 - Introduction

**It is imperative that this manual is read carefully and understood before installing your equipment. For your future reference please keep this manual in a safe place.**

Thank you for specifying a product from the Francis Searchlights range. All Francis products are designed to give complete customer satisfaction and are manufactured to the highest engineering standards in order to ensure optimum performance and service life.

The Francis Xenon range combines features proven over many years service in the most hazardous conditions in both marine and land installations.

In order to prolong the life and performance of your product, we recommend that you only specify Francis Searchlights spare parts. This will also ensure that any warranties on your equipment will not be invalidated. Information on spares ordering and parts is provided in this manual.

Should you ever need to contact Francis Searchlights Ltd. regarding your equipment, please quote the Product Serial Number at all times.

## 2 - Safety Precautions

The following instructions must be adhered to, in order to ensure a safe working environment and the safety of the user.

**Note: When unpacking or manoeuvring the searchlight into its fixing position, suitable lifting points must be used in order to prevent damage to the equipment or personal injury.**

- Because of the high internal pressure within the lamp, there is a risk of explosion in either a hot or cold state;
- During operation this lamp emits intense UV radiation which is harmful to the eyes and skin. Suitable protection should be worn;
- The high luminance of the arc can cause severe damage to the eye if viewed directly. ALWAYS wear suitable protective goggles when viewing the lamp;
- Always use protective sleeves supplied with the lamp whilst handling;
- Should it be necessary to examine the lamp with the front bezel removed, always use a protective shield and wear goggles to ensure a safe working environment;
- Searchlights get hot. Never touch the unit when lit and always allow 15 to 20 minutes for cooling down after turning the searchlight off;
- Never place anything on or cover the searchlight when in use;
- Ensure the lamp has cooled sufficiently before removal;
- If undue force appears necessary to remove the lamp, the equipment should be inspected by a competent person or contact the manufacturer;
- When disposing of lamps, return the lamp, via the supplier, to the lamp manufacturer in its complete packaging;
- Due to the vast range of lamps available it may appear possible that more powerful lamps can be used in the equipment than for which it was designed. Even when the unit will physically accept a higher wattage or voltage lamp, this substitution is not recommended and is dangerous. This action will also void any warranties on the equipment.
- Always refer to the lamp manufacturer's technical data when dealing with lamps.

### 3 – Technical Information

This product has been designed to operate in accordance with the product specification. The LX230 100watt H.I.D Xenon searchlight has the following features:

- All marine grade materials and fixings;
- Stove enamel painted;
- Full 360° horizontal rotation;
- Vertical movement  $\pm 45^\circ$  (Deck);  $-25^\circ$  to  $+30^\circ$  (Cabin);
- Instant lamp re-strike. No cooling down time required;
- Economical 3000 hour lamp life;
- Toughened front glass;
- Colour temperature 6000K;
- Sealing to IP66.

The searchlight also performs to the following optical data:

- Xenon H.I.D light source
- Lamp Wattage - 100 Watts;
- Supply voltage – 9.5v to 30v DC;
- Peak Beam Candlepower – 3,100,00 Lux;
- Range – 1,761 metres;
- Adjustable lamp focus, 5° spot to 29° flood;
- Temperature range:  $-40^\circ\text{C}$

In order that the searchlight operates correctly it is imperative that competent personnel are responsible for the installation, operation and servicing of this equipment. Failure to adhere to this advice may cause premature failure or incorrect operation of the searchlight, which may damage the equipment or cause personal injury.

## 4 - Unpacking and Installation Instructions

The following instructions should be read and fully understood prior to installing the equipment to ensure that the correct procedures are followed, and all safety precautions are observed.

**Note: If the equipment has been in storage for a considerable amount of time, it is advisable to conduct a routine maintenance check on all parts before installation.**

### **Safety Precautions**

This equipment should not be connected to an electrical supply before being installed. Installation procedures should be adhered to in order to ensure a safe working environment and reduce the risk of damage or personal injury.

### **Preparing the Mounting Position**

Mark out and drill the fixing holes through the deck, using the template provided. If anti-vibration mounts are to be fitted, the fixing holes for the mounts should also be marked out and drilled. Prior to manoeuvring the searchlight into its' fixing position, the AV mounts should be fitted to the base. In the case of cabin control models, a centre hole is also required to allow the mechanism to pass through.

Fit the 'O' ring in position and bolt the searchlight down securely. On an uneven surface it is necessary to use a suitable sealant, such as silicone, to ensure a weatherproofed joint. For cabin control models it is necessary to remove the Underdeck control assembly prior to installation.

Using the Allen key provided, the five grub screws on the Underdeck mechanism should be loosened to allow the Underdeck control assembly to be removed. The outer tube can now be positioned through the centre hole. The searchlight base can now be securely fixed as stated above.

Upon installation, re-assemble the Underdeck control mechanism ensuring the grub screws are secure and the mechanism operates correctly.

## **Fitting Instructions for Lite Range Cabin Model**

### **Preparing the Mounting Position**

Using the template provided mark out and drill the fixing holes through the deck or cabin roof. In the case of cabin control models, a centre hole is also required to allow the mechanism to pass through.

### **Mounting the Searchlight**

#### **For Deck Models:**

Fit the 'O' ring in position and bolt the searchlight base securely down. On an uneven surface it is necessary to use a suitable sealant, such as silicone, in order to ensure a weather proofed joint.

#### **For Cabin/Cabin Pedestal Models:**



1. Remove the Base Lock Wheel.

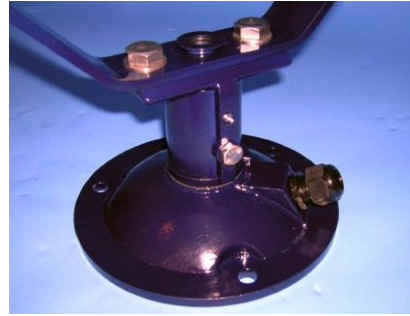

2. Replace Lock Wheel with M8 x 10 hexagon screw in the bottom fixing



3. Now remove the following items as these are only required on deck models Barrel Lock Wheel, Elevation Link and fixings



4. When installing the Under-Deck mechanism, first separate the following items. U-Piece Assembly, M8 nyloc nut, M8 plain washer, M12 plain washer, Rubber Bellows, Bellows Top Bush and the Push Rod Top Bush

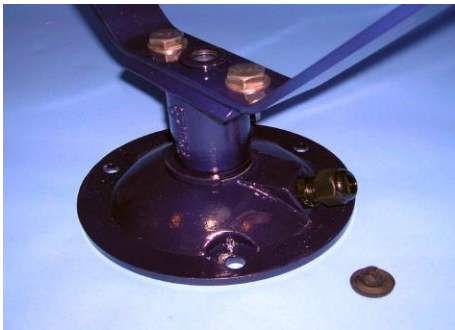

**5.** Remove the Blanking Plug from the Bellows Bottom Bush.



**6.** Insert the Under Deck through the centre hole making sure it's aligned as photos below

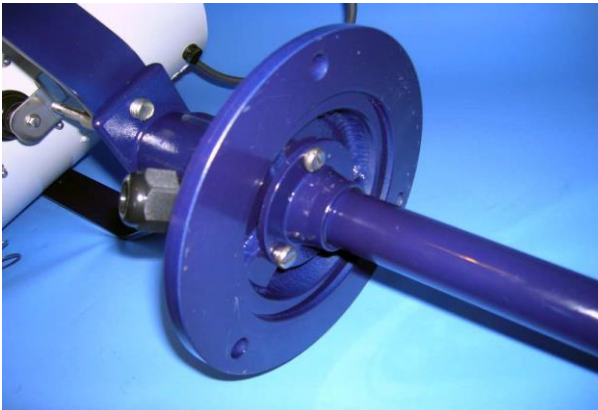
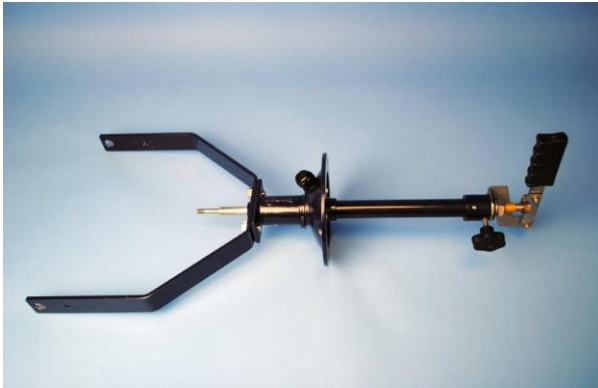

**7.** Fasten the Under-Deck mechanism Using the 3 off M6 X 16 pan head screws and spring washers



**8.** Re-Fit the following items:  
Push Rod Top Bush



**9.** Bellows Top Bush.

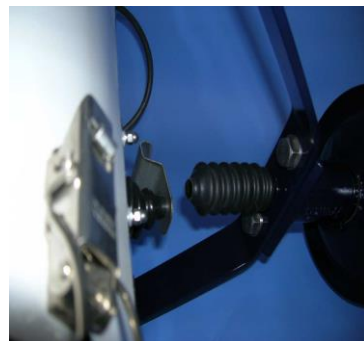

**10.** Bellows.



**11.** M12 plain washer. U-Piece Assy. M8 plain washer. M8 nyloc nut.



12. Make sure the mechanism is in this position before tightening the M5 x 8 hexagon screw onto the flat of the push rod.

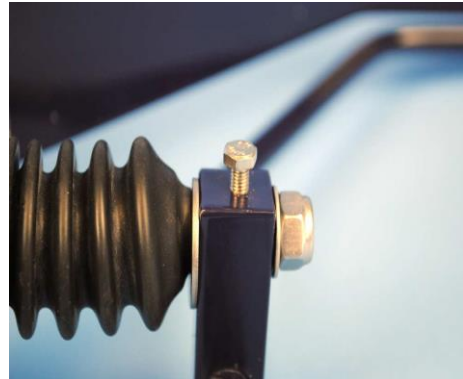

13. U-Piece fixings.

14. Fix the U-Piece Assembly using U-Piece fixings make sure there is a plain washer both sides of the U-Piece Bush.



15. Completed.  
Make sure the Searchlight pans and tilts correctly.

**For Pedestal Models:**

Mark out and drill through cabin roof using the template provided. Remove the cable gland in the base and replace with the blanking plug supplied. Secure the pedestal to the deck using appropriate fixings and then mount the searchlight to the pedestal and secure using the fixings provided. A drilled hole is also required in the deck to allow for the connection to an electrical supply. The searchlight is supplied with 3 metres of supply cable so that the installer can choose a suitable connection point.

## 5 - Electrical Installation

For safety purposes, only competent personnel should perform the electrical installation. All equipment should be installed to current Electrical Regulations and Standards.

In order to obtain the maximum light output from the searchlight, it is essential that the full operating voltage of the lamp fitted be applied to the lampholder contacts.

### **Method of Electrical Connection**

- 1) Disconnect the supply before working on the electrical system;
- 2) The searchlight must be connected to a fused electrical supply, using suitably sized cable;
- 3) If the searchlight is located a considerable distance from the supply, provision must be made in the cable size in order to overcome the voltage drop.
  
- 4) Whenever possible cable terminations should be made below deck and with approved terminal devices;
- 5) If a spare auxiliary fuse or circuit breaker is not available, one of the correct type and rating should be fitted and connected to a positive supply. It is advisable to locate a bus bar or main connection and avoid any direct connection to the supply:

## 6 - Operating Instructions

This equipment is designed for use out of doors, in free air. Never place anything on or cover the searchlight when in use as this may present a hazard.

The searchlight can be positioned using the elevation and base plate lockwheels. When in the desired position the lockwheels should be securely fastened to maintain position.

The beam of the searchlight can be adjusted to give a variety of beam types. Using the rear knob on the back panel, the desired beam can be achieved for any particular application. The beam will move through 'spot' to 'flood'. In order to fix the beam type; simply release the knob at the desired position.

The searchlight is also fitted with a breather at the rear of the searchlight which ensures a steady airflow to prevent any vacuum forming within the barrel.

**This product should not be used for any purpose other than for which it was designed. Any modifications to the product should not be undertaken without consulting the manufacturer.**

## Setting to Work

Safe service in use necessitates the strict observance of the following precautions.

- Any article fabricated from quartz or glass is inherently fragile and care should therefore be taken, at all times, when handling lamps;
- Eye protection must be worn when handling lamps that have been removed from their packaging materials. The protective sleeve should not be removed from the lamp for safety reasons, as there is a remote possibility of the lamp shattering violently, especially if it is subjected to mechanical shock or vibration;
- Ensure that the power rating of the lamp to be fitted is suitable for the lamphouse and power supply equipment;
- Always isolate the equipment from the supply before inserting a lamp;
- Do not twist or bend the fused quartz bulb when fitting the lamp as mechanical stresses MUST be avoided;
- When inserting or removing a lamp, always hold it securely by its' base in order to prevent breakage between base and bulb;
- The lampholder must not exercise mechanical tensions on the lamp, neither during insertion or operation.
- For safety reasons, the lamp should be replaced once it has reached its' average life, and not later than 1.25 times the stated life. With continuing use the risk of the lamp exploding increases due to alterations within the quartz;
- Before the protective sleeve is removed, suitable protection must be worn i.e face mask and gloves with wrist protection;
- Never touch the quartz bulb with bare hands, as fingerprints will make the glass cloudy and cause a severe loss of light. This may also cause recrystallisation and thus weaken the bulb material. Should the bulb be inadvertently touched, remove fingerprints with methylated spirit and a clean, soft paper towel. The bulb should then be wiped with distilled water. NOTE: ALWAYS WEAR MASK AND GLOVES DURING CLEANING;
- All packaging and the protective sleeve must be retained for re-use. Whenever removing a lamp, the protective sleeve must always be used for safety reasons;

**In all circumstances the lamp manufacturer's data should be referred to when dealing with lamps.**

## 7- Fault Finding

All fault finding must be conducted by a competent person or qualified Electrical Engineer.

Please refer to the following table for the trouble-shooting of Xenon lamps.

### **Failure of Lamp to ignite**

In the event of the lamp failing to light the following steps should be taken:

- 1) Check that the supply is connected to the input of the Ballast and check all connections as per the wiring diagram C25888 or C26207. On operation if the lamp does not light, switch off supply and check all fuses;

**Any further tests to be carried out with regards to lamp failure must be conducted by a competent electrical engineer and should not be carried out in an explosive atmosphere.**

- 1) Before a xenon lamp will ignite, the electrically insulated gas between the electrodes must be ionised. This is done by the ignitor which produces a high frequency voltage (up to 25,000 volts or higher). Switching the lamp on activates the ignitor. A cracking or hissing noise should be heard. The ignitor is housed within the rear of the searchlight barrel. If found to be faulty a new ignitor must be fitted.

## 8 - Maintenance and Servicing

In order to prolong the service life and performance of your searchlight, the following maintenance guidelines are recommended:

- Maintenance checks should be conducted before every voyage or at least every three months;
- Before checking, disconnect the equipment from the supply;
- Visually inspect the condition of the equipment;
- Any major or minor structural damage should be rectified immediately in order to reduce sympathetic wear;
- After inspection it may be necessary to clean the inside of the searchlight. The following procedure should be adhered to:
  - Remove the front bezel;
  - Clean the front glass inside and out using a proprietary glass cleaner;
  - Clean the reflector if required;
  - Ensure that the lampholder is free from corrosion or other damage;
- It is advisable to check all seals and gaskets for signs of degradation. Renew if necessary;
- Upon completing all maintenance requirements, the searchlight should be tested for full working order (approximately 20 minutes).

**If in any doubt as to the correct servicing procedures to adopt please contact your distributor/agent or the manufacturer who will be able to advise the best course of action for your product.**

### **Notes for Lamp Fitting/Removal for LX230 100w H.I.D Xenon**

To fit lamp:

- Remove lamp from packaging, ensuring protective jacket is still in place;
- Remove rear panel from searchlight by unfastening the eight cap head screws. Care should be taken when removing the rear panel assembly so that no damage to the lamp is incurred;
- Loosen the two M3 screws on the lamp holder & disconnect the two lamp leads.
- Remove lamp from protective packaging.
- Replace the lamp by reconnecting the lamp leads & nipping up the M3 screws
- Replace the rear panel and fasten down the M4 cap head screws securely, ensuring a good seal is achieved;

Note: Retain jacket for future use.

## 9 – General Assembly and Wiring Diagrams

| <b>Drawing Number</b> | <b>Description</b>                   |
|-----------------------|--------------------------------------|
| A6083                 | LX230 100w Deck G.A                  |
| A6084                 | LX230 100w Cabin G.A                 |
| A6085                 | LX230 100w Deck Pedestal G.A         |
| A6086                 | LX230 100w Cabin Pedestal G.A        |
| C26221                | HV Junction Box Assembly (240v Only) |
| C25888                | Wiring Diagram LV                    |
| C26207                | Wiring Diagram HV                    |







DATE 2.12.12  
 1 AS FIRST DRAWING

16 15 14 13 12 11 10 9 8 7 6 5 4 3 2 1

A B C D E F G H J K

0 10 20 30 40 50mm

THIRD ANGLE PROJECTION

DO NOT SCALE DRAWING

FIRST USED ON LX230DP

4 HOLES #12.50 EQUI-SPACED AS SHOWN ON A 190.00 PCD

BASE FIXING DETAILS

FOR SCREW FIXING KIT SEE (3) ITEM (4) NOT SHOWN

ITEM PART No. DRG No. DESCRIPTION QTY QTY

1 A6083 LX230DP G.A. 1 1

2 C20719 PEDESTAL ASSY 1 1

3 C20747 DECK PED CONVERSION KIT 1 1

4 C26221 HV JUNCTION BOX ASSY 0 1

(388)

(1498)

(1368)

(1117)

(309)

A6085 12/24v  
 A6106 240v

STANDARD PRACTICE  
 Detail as cut/machined edges  
 (Base corners R0.25(4mm) U.C.S.)

© 2012 A1 CONT ON SHEET

FRANCIS SEARCHLIGHTS LIMITED . UNION ROAD . BOLTON . BL2 2HJ

LX230DP 100w 12/24/240v G.A.

FRANCIS

SEARCHLIGHTS LIMITED

2012 A1 CONT ON SHEET

PART No. DRG No. A6085 1

SHEET 1

DATE 2.12.12

SCALE 1:2

TOLERANCES

General 3

Finish 2

Seed Casting to ISO 8062 CT10

Die Casting to ISO 8062 CT8

Material Refer to parts 2

ALL DIMENSIONS IN MILLIMETRES

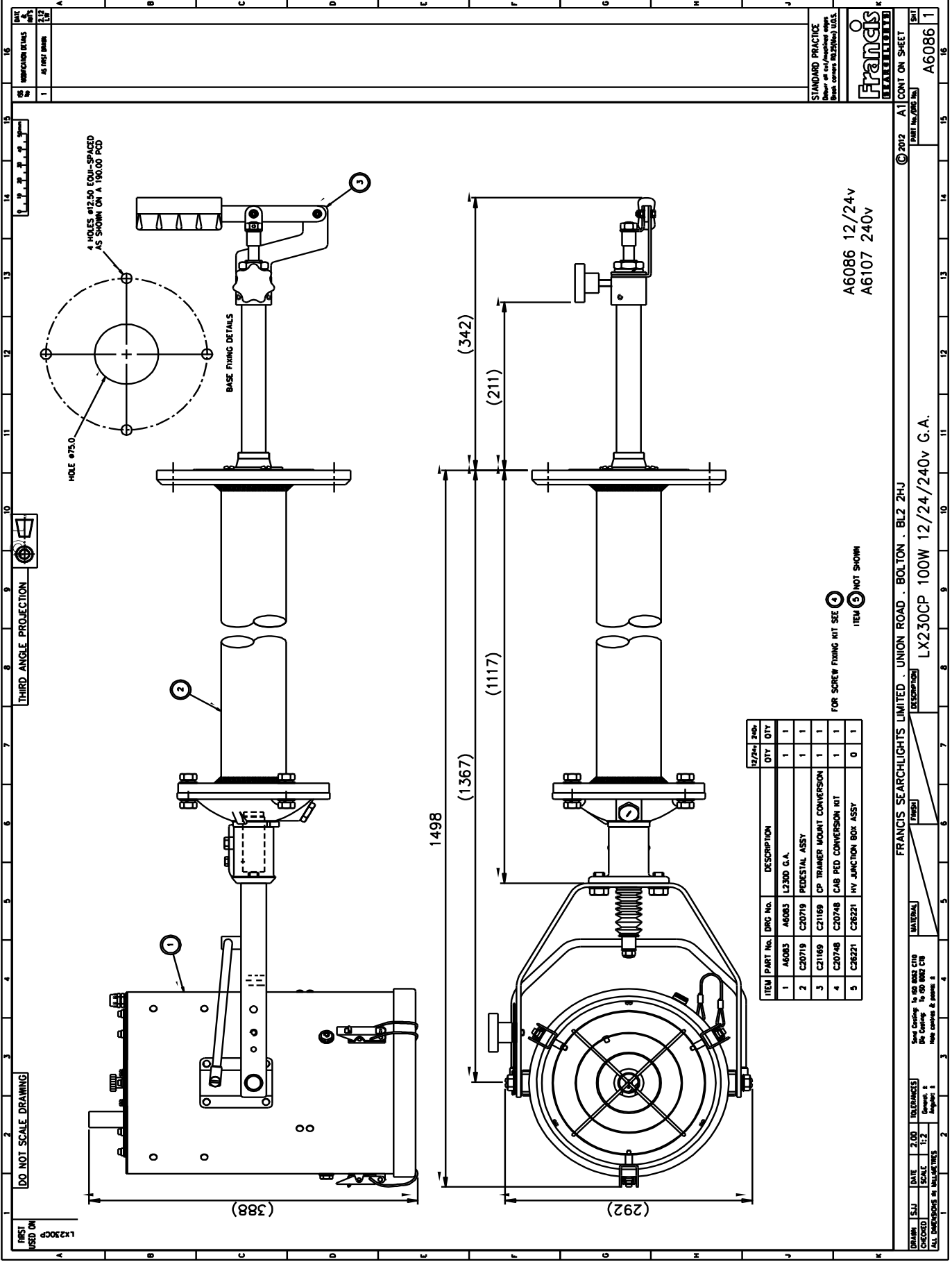

DO NOT SCALE DRAWING

FIRST USED ON L230CP

| ITEM | PART No. | DRG No. | DESCRIPTION                 | QTY. | QTY. |
|------|----------|---------|-----------------------------|------|------|
| 1    | A6083    | A6083   | L2300 G.A.                  | 1    | 1    |
| 2    | C20719   | C20719  | PEDESTAL ASSY               | 1    | 1    |
| 3    | C21169   | C21169  | CP TRAINER MOUNT CONVERSION | 1    | 1    |
| 4    | C20748   | C20748  | CAB PED CONVERSION KIT      | 1    | 1    |
| 5    | C26221   | C26221  | HV JUNCTION BOX ASSY        | 0    | 1    |

FOR SCREW FIXING KIT SEE ITEM ①  
ITEM ⑤ NOT SHOWN

A6086 12/24V  
A6107 240V

FRANCIS SEARCHLIGHTS LIMITED . UNION ROAD . BOLTON . BL2 2HJ

DATE 2.00 TOLERANCES: See Drawing to ISO 2800 C10  
SCALE 1:2 Drawn to ISO 1000 C10  
CHECKED BY: [Signature] Approved by: [Signature]

STANDARD PRACTICE: The drawing shall be made in accordance with BS 8888:1986 (ISO 10301) U.K.S.

© 2012 A1 CONT ON SHEET

PART No. 200 No. A6086 1

FRANCIS SEARCHLIGHTS LIMITED

FIRST USED ON 1609

DO NOT SCALE DRAWING

BOX DIM'N 180 x 180 x 130

NOTE

- 1..USE SCREW & FIXINGS PROVIDED
- SCREW NUT FULLY ONTO SCREW
- SO SCREW DOES NOT PROTRUDE
- THROUGH CHASSI PLATE
- 2..ITEMS 11 & 12 NOT SHOWN
- POSITION CENTRAL ON LID
- 3..ITEMS 21, 22 & 23 NOT SHOWN

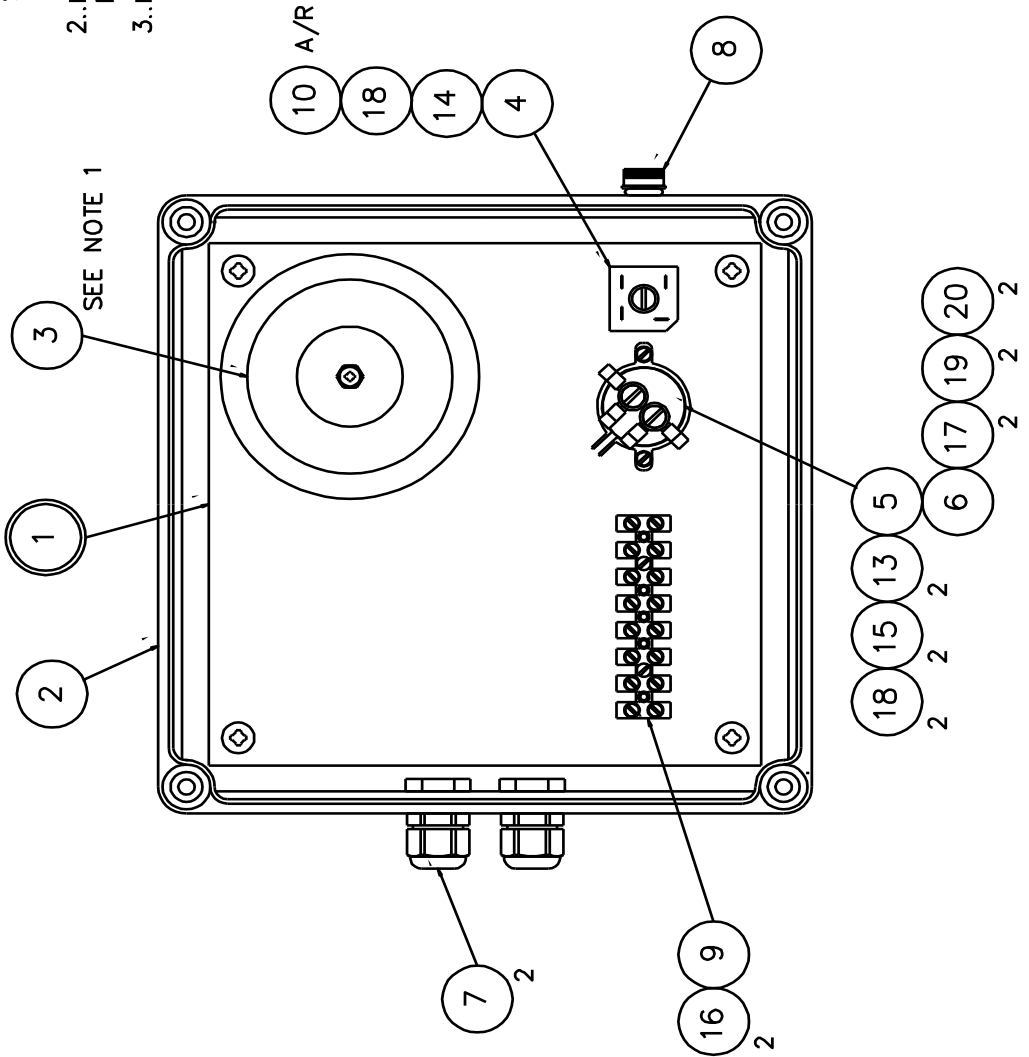

| ITEM | PART No. | DRG No. | DESCRIPTION          | QTY       |
|------|----------|---------|----------------------|-----------|
| 1    | C26216   | C26216  | CHASSIS PLATE ASSY   | 1         |
| 2    | C26217   | C26217  | ENCLOSURE            | 1         |
| 3    | C24813   |         | TRANSFORMER          | 1         |
| 4    | C24072   |         | RECEIVER             | 1         |
| 5    | C24823   |         | CAPACITOR            | 1         |
| 6    | C25846   |         | CAPACITOR CLIP       | 1         |
| 7    | C10158   |         | GLAND                | 2         |
| 8    | C22268   |         | WEATHER ASSY         | 1         |
| 9    | C19133   |         | TERMINAL STRIP 32A   | 1 (8 WAY) |
| 10   | C14232   |         | HEATSHANK COMPOUND   | A/R       |
| 11   | C21464   |         | LABEL DANGER 230V    | 1         |
| 12   | C22036   |         | LABEL ISOLATE SUPPLY | 1         |
| 13   | C14868   |         | RING TAG             | 4         |
| 14   | C10620   |         | SCREW M5 x 16 PH 40  | 1         |
| 15   | C10208   |         | SCREW M5 x 12 PH 40  | 2         |
| 16   | C10033   |         | SCREW M3 x 16 PH 40  | 2         |
| 17   | C10131   |         | SCREW M3 x 10 PH 40  | 2         |
| 18   | C08392   |         | WASHER M5 PLAIN      | 3         |
| 19   | C08028   |         | WASHER M3 PLAIN      | 2         |
| 20   | C10747   |         | WASHER M3 S/C SPRING | 2         |
| 21   | C13872   |         | CABLE 1.5mm RED      | A/R       |
| 22   | C13873   |         | CABLE 1.5mm BLACK    | A/R       |
| 23   | C19112   |         | CABLE 1.5mm G/Y      | A/R       |

STANDARD PRACTICE  
 FRANCIS SEARCHLIGHTS LTD.  
 BOLTON, LANCASHIRE, ENGLAND

Francis  
 SEARCHLIGHTS

© 2015 A1 CONT ON SHEET  
 PART NO. DRG. NO.  
 C26621

FRANCIS SEARCHLIGHTS LIMITED - UNION ROAD - BOLTON - BL2 2HJ  
 HV JUNCTION BOX ASSEMBLY (LX230 HV)

| DRWING   | REV | DATE | SCALE | QUANTITIES | EXCEPTIONS | MATERIAL | FRANCIS |
|----------|-----|------|-------|------------|------------|----------|---------|
| EXCEEDED |     |      | 1:1   |            |            |          |         |

Send Complete to HQ ENG CTR  
 for Copying to HQ ENG CTR  
 also copies to plant 1

Author 1  
 Designer 1

ALL DIMENSIONS IN MILLIMETRES





## 10 – Spare Parts List

The following spare parts can be ordered directly from the manufacturer:

| <b>Part Number</b> | <b>Description</b>               |
|--------------------|----------------------------------|
| D25858             | 100w Xenon Lamp                  |
| C25857-00          | 100w Ballast & Ignitor Unit      |
| C08865-00          | Front glass                      |
| C12888-00          | Front Glass Infra Red (Optional) |
| C21141-00          | Front glass gasket               |
| C25859-00          | Rear Plate Gasket                |
| C10168-00          | Base O' Ring                     |
| C22268-01          | Breather Assembly                |
| C21348-00          | Reflector                        |

In order to prolong the life and performance of your product, we recommend that you only specify Francis Searchlights spare parts. This will ensure that any warranties on your equipment will not be invalidated.

When ordering spare parts please contact the Sales Department at Francis Searchlights Limited. Please quote searchlight model and serial number at all times. This will enable a fast response to your spares' requirements.