



## User Instruction & Installation Manual

# Voyager 2



### Product Reference Number:

**A7186 VX500 100w 24v Xenon**

#### *Manufacturer's details:*

Francis Searchlights Ltd  
Union Road, Bolton  
Lancashire, BL2 2HJ, UK  
Tel: +44 (0) 1204 558960  
Fax: +44 (0) 1204 558979  
<http://www.francis.co.uk>  
E-mail: [sales@francis.co.uk](mailto:sales@francis.co.uk)

#### *Distributor details:*

--

**Manual Part Number: C27399**

Issue: 2      18/4/18

## CONTENTS

- 1 - Introduction
- 2 - Safety Precautions
- 3 - Technical Information
- 4 - Unpacking and Installation Instructions
- 5 - Electrical Installation
- 6 - Operating Instructions
- 7 - Fault Finding
- 8 - Maintenance and Servicing
- 9 - Wiring Diagrams & General Assembly
- 10 - Spare Parts List

# 1 - Introduction

**It is imperative that this manual is read carefully and understood before installing your equipment. For your future reference please keep this manual in a safe place.**

Thank you for specifying a product from the Francis Searchlights range. All Francis products are designed to give complete customer satisfaction and are manufactured to the highest engineering standards in order to ensure optimum performance and service life.

The Francis range combines features proven over many years service in the most hazardous conditions in both marine and land installations.

In order to prolong the life and performance of your product, we recommend that you only specify Francis Searchlights spare parts. This will also ensure that any warranties on your equipment will not be invalidated. Information on spares ordering and parts is provided in this manual.

Should you ever need to contact Francis Searchlights Ltd. regarding your equipment, please quote the Product Serial Number at all times.

## 2 - Safety Precautions

The following instructions must be adhered to, in order to ensure a safe working environment and the safety of the user.

**Note: When unpacking or manoeuvring the searchlight into its fixing position, suitable lifting points must be used in order to prevent damage to the equipment or personal injury.**

- Because of the high internal pressure within the lamp, there is a risk of explosion in either a hot or cold state;
- During operation this lamp emits intense UV radiation which is harmful to the eyes and skin. Suitable protection should be worn;
- The high luminance of the arc can cause severe damage to the eye if viewed directly. ALWAYS wear suitable protective goggles when viewing the lamp;
- Always use protective case supplied with the lamp whilst handling;
- Should it be necessary to examine the lamp with the lid removed, always use a protective shield and wear goggles to ensure a safe working environment;
- Searchlights get hot. Never touch the unit when lit and always allow 15 to 20 minutes for cooling down after turning the searchlight off;
- Never place anything on or cover the searchlight when in use;
- Ensure the lamp has cooled sufficiently before removal;
- If undue force appears necessary to remove the lamp, the equipment should be inspected by a competent person or contact the manufacturer;
- When disposing of lamps, return the lamp, via the supplier, to the lamp manufacturer in its complete packaging;
- Due to the vast range of lamps available it may appear possible that more powerful lamps can be used in the equipment than for which it was designed. Even when the unit will physically accept a higher wattage or voltage lamp, this substitution is not recommended and is dangerous. This action will also void any warranties on the equipment.

Always refer to the lamp manufacturer's technical data when dealing with lamps.

### 3 - Technical Information

This product has been designed to operate in accordance with the product specification. The VX500 RC searchlight has the following features:

- All marine grade materials and fixings;
- 100w Xenon HID Ballast unit;
- Parabolic glass reflector;
- Instant lamp re-strike. No cooling down time required;
- Economical 3000 hour lamp life;
- 350° horizontal rotation;
- Vertical movement +20° to -20°;
- Motor speed 1°- 20°/sec (Pan). 1°-3.5°/sec (Tilt);
- RS485 connectivity & auto home positioning;
- Remote focus facility;
- Self-Regulating internal heater;
- Toughened front glass;
- Sealing to IP66;

**The 100w Xenon searchlight also performs to the following optical data:**

- Xenon HID light source;
- Lamp wattage – 100 watts;
- Supply voltage – 24v DC;
- Peak Beam Candlepower - 4.3 million Lux;
- Range – 2081 metres;
- Adjustable lamp focus, 5° spot to 29° flood;
- Temperature range -50°C

In order that the searchlight operates correctly it is imperative that competent personnel are responsible for the installation, operation and servicing of this equipment. Failure to adhere to this advice may cause premature failure or incorrect operation of the searchlight, which may damage the equipment or cause personal injury.

## 4 - Unpacking and Installation Instructions

The following instructions should be read and fully understood prior to installing the equipment to ensure that the correct procedures are followed, and all safety precautions are observed.

**Note: If the equipment has been in storage for a considerable amount of time, it is advisable to conduct a routine maintenance check on all parts before installation.**

### **Safety Precautions**

This equipment should not be connected to an electrical supply before being installed. Installation procedures should be adhered to in order to ensure a safe working environment and reduce the risk of damage or personal injury.

### **Preparing the Mounting Position**

Mark out and drill the fixing holes through the deck. When in the desired position fasten the searchlight firmly down. On an uneven surface it may be necessary to use a suitable sealant such as silicone, in order to ensure a weatherproofed joint. If no cabling is required to be seen on deck, there is the option to wire from underneath the base directly into the deck. See drawing A7180 for details.

## 5 - Electrical Installation

### Note: ~

**When the main power is first applied to the searchlight, the searchlight will carry out a self-test, it will Pan to the left limit and Tilt down to the limit, once this is complete, the searchlight will then move to the centre and horizontal, during this please do not try and operate the searchlight while this test is being carried out. Once the searchlight is back at centre the searchlight can then be operated normally, by pressing the Panel button on the control panel.**

For safety purposes, only competent personnel should perform the electrical installation. All equipment should be installed to current Electrical Regulations and Standards.

In order to obtain the maximum light output from the searchlight, it is essential that the full operating voltage of the lamp fitted be applied to the lampholder contacts.

### Method of Electrical Connection

- 1) Disconnect the supply before working on the electrical system;
- 2) The searchlight must be connected to a fused electrical supply, using suitably sized cable;
- 3) The junction box should NOT be positioned more than 6 metres away from the searchlight using standard cables supplied.
- 4) Whenever possible cable terminations should be made below deck and with approved terminal devices;
- 5) If a spare auxiliary fuse or circuit breaker is not available, one of the correct type and rating should be fitted and connected to a positive supply. It is advisable to locate a bus bar or main connection and avoid any direct connection to the supply:

### Installation Guidelines

**A typical installation and connection routine for the VX500RC searchlight is as follows:**

Referring to wiring diagram **C27393** a supply is fed to the junction box which then provides a common feed to the searchlight and joystick panel.

The following cables have been supplied as standard: -

- 4 metres of 2 pair twisted 0.22mm screened cable from the junction box to searchlight.
- 4 metres of 3 cores 2.5mm cable from the junction box to the 24v supply.
- 4 metres of 3 cores 2.5mm cable from the junction box to searchlight.
- 4 metres of 2 pair twisted 0.22mm screened cable from the junction box to the joystick panel.

## 6 - Operating Instructions

This equipment is designed for use out of doors, in free air. Never place anything on or cover the searchlight when in use as this may present a hazard.

### **Switch On**

The panel is activated using the PANEL button. This will illuminate brightly when the panel is active. Alternate operations of the PANEL button will switch the panel on and off.

### **Lamp Control**

When the panel is active pressing the LAMP, button will switch the lamp on or off. If the control panel is switched off with the PANEL button the lamp will switch off.

### **Focus Control**

The lamp focus can be adjusted using the FOCUS button. Lamp focus will adjust continuously whilst FOCUS is pressed.

### **Beam Direction**

The beam direction can be adjusted using the joystick when the panel is active. Moving the joystick left or right will pan the beam clockwise or anticlockwise. Moving the joystick up or down will move the beam up or down. The speed of movement is proportional to the movement of the joystick. It is possible to move the beam in both directions at once by moving the joystick diagonally.

### **Home**

The lamp can be returned to a pre-set home position. By default, this is dead ahead with the beam level although different positions can be programmed as described below. To send the lamp to the home position switch the panel off then press the LAMP button.

### **Set New Home Position**

To set a new home position move the lamp to the new desired home position. Switch the panel off then press the joystick down to its limit and press the lamp button. The current position will now be the new home position.

### **Set Motion Limit** (only available when Remote Focus is fitted)

The lamp travel can be limited in either axis and either direction. To set a new limit switch the panel on and move the lamp to the desired limit position. Switch the panel off then press and hold the focus button whilst moving the joystick full travel in the direction of the desired limit. Hold in this position for 4 seconds. For example, to set a limit to the tilt up motion; -

1. Switch panel on and drive lamp to desired tilt up limit position.
2. Switch panel off.



3. Press and hold the FOCUS button and hold joystick in the full up position for 4 seconds.
4. Tilt up motion will now be inhibited above the current position.

### **Clear Motion Limits**

Motion limits as set above can be cleared by switching the panel off then pressing and holding the focus button and lamp buttons together for 10 seconds.

### **Adjusting Panel Illumination**

The panel illumination and indicators intensity can be adjusted to suit ambient light levels. To adjust the intensity, switch the panel on then switch it off with the PANEL button and keep the PANEL button pressed. To increase intensity, move the joystick to the right. To decrease move to the left. Note that the panel button must be kept depressed whilst the joystick is moved. All indicators will illuminate whilst adjustments are performed. Adjustment is complete when the panel button is released.

### **Obtaining Fault Status**

Fault codes can be accessed by switching the control panel on with the PANEL button and keeping the PANEL button pressed for 10 seconds. Fault codes are indicated by the PANEL button flashing a number of times related to the fault. Fault codes are detailed below. If more than one fault is present the PANEL button will indicate them in sequence.

1. Pan Limit. – Either of the pan limit switches operated. Note that this may not actually be a fault. The LED will flash when a limit switch is operated under normal circumstances i.e. the lamp is at the limit of travel. This will also indicate when a variable limit is reached.
2. Tilt Limit. – Either of the tilt limit switches operated. Note that this may not actually be a fault. The LED will flash when a limit switch is operated under normal circumstances i.e. the lamp is at the limit of travel. This will also indicate when a variable limit is reached.
3. Pan motor over current. – The pan motor is taking excessive current. The motor will be disabled for a period when this occurs. Fault indication will remain until power is removed or the fault is corrected.
4. Tilt motor over current. – The tilt motor is taking excessive current. The motor will be disabled for a period when this occurs. Fault indication will remain until power is removed or the fault is corrected.
5. Focus motor over current. – The focus motor is taking excessive current. The motor will be disabled for a period when this occurs. Fault indication will remain until power is removed or the fault is corrected.
6. FBUS interface over current. – The speed control card supplies 24VDC to the remote-control panels. This fault indicates the 24VDC output is taking excessive current. The FBUS supply output will switch off. To

restore this output, remove the supply from the speed control card for a period.

7. Anti-condensation heater output over current. – The 24VDC anti condensation heater output is taking excessive current. The heater output will switch off. To restore this output, remove the supply from the speed control card for a period.
8. Limit Switch Error. Some lamp types do not use all or some limit switches. If an invalid limit switch input is detected it is probable the speed control card is set to the wrong product or there is a wiring error.
9. Datum Error. The start-up datum system has not completed correctly.
10. Product type not set or corrupt. The product type has not been set, has been set incorrectly or is corrupt.
11. Supply voltage out of tolerance. The 24V supply is outside the range 18-30V.



## **Always isolate the equipment from the supply when fitting a lamp** **See next sheet for fitting aid diagram**

### **Before fitting the lamp:**

- Loosen and remove five M8 socket bolts with the dubo washer on the underneath of the searchlight, then remove the upper hood of the searchlight & store along with the bolts and washers in a safe area.

### **After fitting the lamp,**

- Replace the upper hood, ensuring the groove aligns correctly with the glass gasket replace the bolts and washers and make sure they are securely fastened.

### **When fitting the lamp:**

- Always isolate the equipment from the supply when inserting a lamp;
- Ensure the circuit is suitably fused;
- Ensure the lamp is of the correct power rating and type;
- Check the lampholder is in a good dry condition. Never allow water to collect in the lamp fitting or come into contact with the lamp;

### **To fit the lamp:**

- Release the M4 grub screw in the lamp holder;
- Remove the lamp by freeing one cable at a time through the slot in the lamp holder;
- Disconnect the two lamp leads;
- Insert new lamp into holder & nip up the M4 grub screw;
- Reconnect the two leads to the lamp;

### **Testing**

Upon correct installation and connection to an electrical supply, the equipment can be tested in order to ensure its' correct performance. A competent person with some knowledge of electrical equipment must carry out this work.

Equipment required:     Multi-meter with leads  
                                  Ammeter

Using the equation  $P=VI$ , the approximate power output of the equipment can be calculated in the following way:

- Using the multi-meter, take a voltage reading across terminals + & - from the 24v dc supply inside the junction box;
- Using the ammeter, take a amps reading from the cable in terminal + from the 24v dc supply inside the junction box;
- Multiply these figures together to give an approximate wattage (Power output).

For example:

Using a 24v 100w xenon lamp:

Voltage reading = 24v; Amps reading = 4 amps

Therefore, Wattage =  $24 \times 4 = 96$  watts

- 1... LOOSEN & REMOVE THE FIVE M8 SOCKET BOLTS WITH THE DUBO WASHERS THAT ARE LOCATED BENEATH THE SEARCHLIGHT HEAD
- 2... REMOVE THE UPPER HOOD OFF THE SEARCHLIGHT & STORE SAFELY ALONG WITH THE BOLTS AND WASHER IN A SAFE AREA
- 3... FOR 100w XENON LAMP  
RELEASE THE M4 GRUB SCREW IN THE LAMPHOLDER  
DISCONNECT THE LAMP LEADS  
REMOVE THE LAMP BY FREING ONE CABLE AT A TIME THROUGH THE SLOT IN THE LAMPHOLDER  
AS WITH THE NEW LAMP, FEED ONE CABLE AT A TIME, THROUGH THE SLOT  
INSERT NEW LAMP INTO HOLDER & NIP UP THE M4 GRUB SCREW  
RECONNECT THE TWO LEADS TO THE LAMP
- 4... AFTER FITTING THE LAMP REPLACE THE HOOD  
ENSURE THE GROOVE IN THE HOOD ALIGNS CORRECTLY WITH THE GLASS GASKET  
NOW REPLACE THE BOLTS & WASHERS & MAKE SURE THEY ARE SECURELY FASTENED

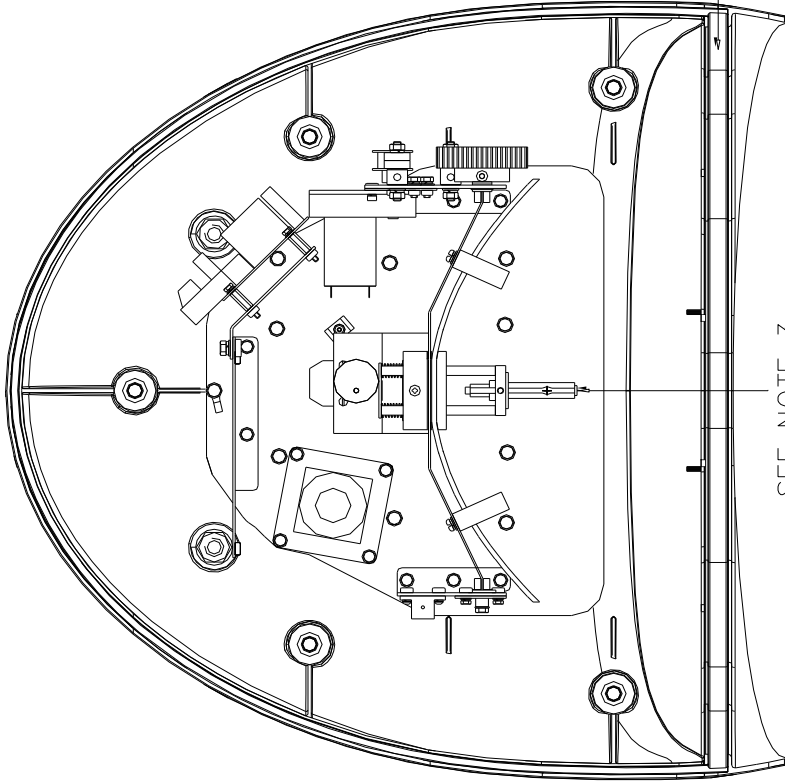

SEE NOTE 3

SEE NOTE 4

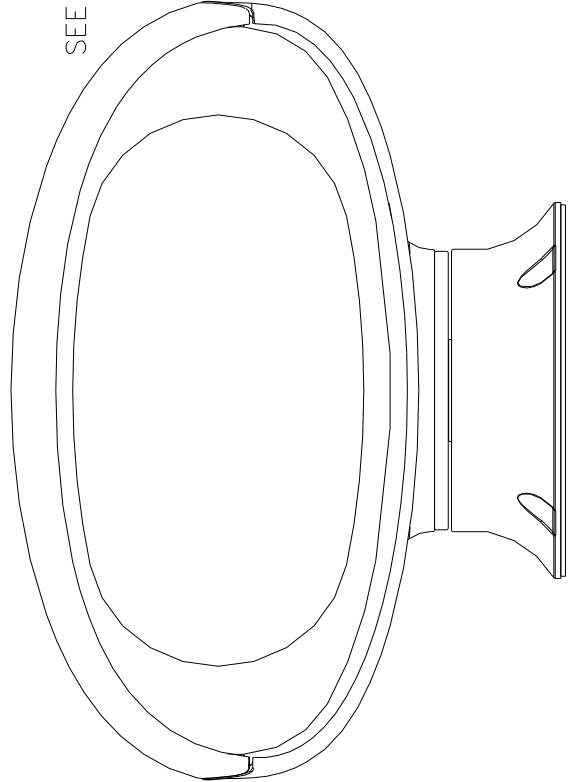

SEE NOTE 2

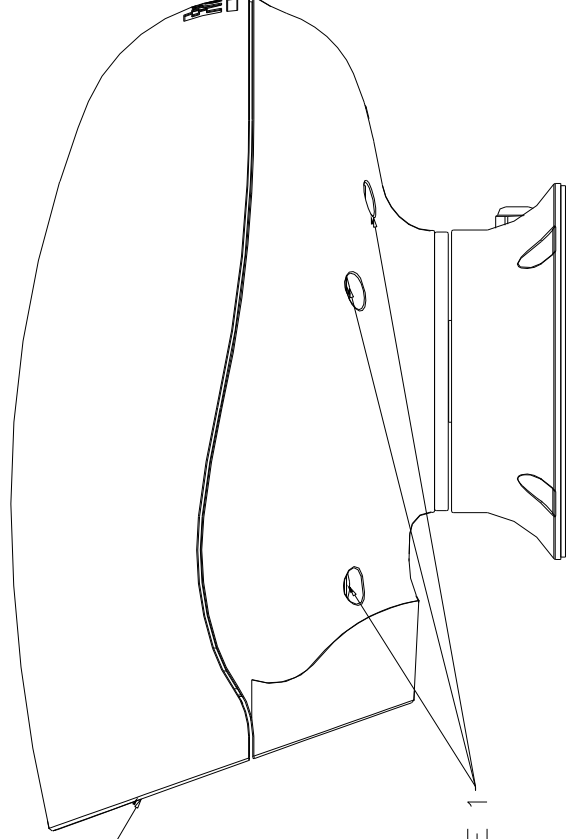

SEE NOTE 1

## **FBUS SPEED CONTROL ASSEMBLY DETAILS**

### **MAINS CONNECTORS**

L Live.  
N Neutral  
E Earth

### **TILT CONNECTOR**

MR Tilt Motor Red Wire (+)  
MB Tilt Motor Black Wire (-)  
ER Tilt Encoder Red Wire (5V). (Voyager Brown Wire)  
EG Tilt Encoder Green Wire (Phase A Output) (Voyager Yellow Wire)  
EW Tilt Encoder White Wire (Phase B Output)  
0V Tilt Encoder Black Wire (Voyager Blue Wire)  
Tilt Limit Switch Common Black Wire  
UL Tilt up Limit Switch Orange Wire  
DL Tilt down Limit Switch Blue Wire

### **PAN CONNECTOR**

MR Pan Motor Red Wire (+)  
MB Pan Motor Black Wire (-)  
ER Pan Encoder Red Wire (5V)  
EG Pan Encoder Green Wire (Phase A Output)  
EW Pan Encoder White Wire (Phase B Output)  
0V Pan Encoder Black & Pan Limit Switch Common  
CL Pan Clockwise Limit Switch Orange Wire (As viewed looking down on lamp)  
AL Pan Anticlockwise Limit Switch (As viewed looking down on lamp)

### **HEAD CONNECTOR**

0 0V Common for Heater & Focus (If Searchlight has an igniter terminal is not used)  
H Heater Active High Output  
F Focus Motor Active High Output  
S Focus position potentiometer.

### **FBUS CONNECTOR**

0 0V out to Joystick Panels  
T Line Terminate (Connect to + for terminate)  
+ FBUS Data +  
- FBUS DATA -  
24 24V Supply out to joystick panels

### **24 VOLT INPUT**

- Negative  
+ Positive

### **LAMP RELAY**

Relay input  
Relay output

# FBUS Speed Control Board

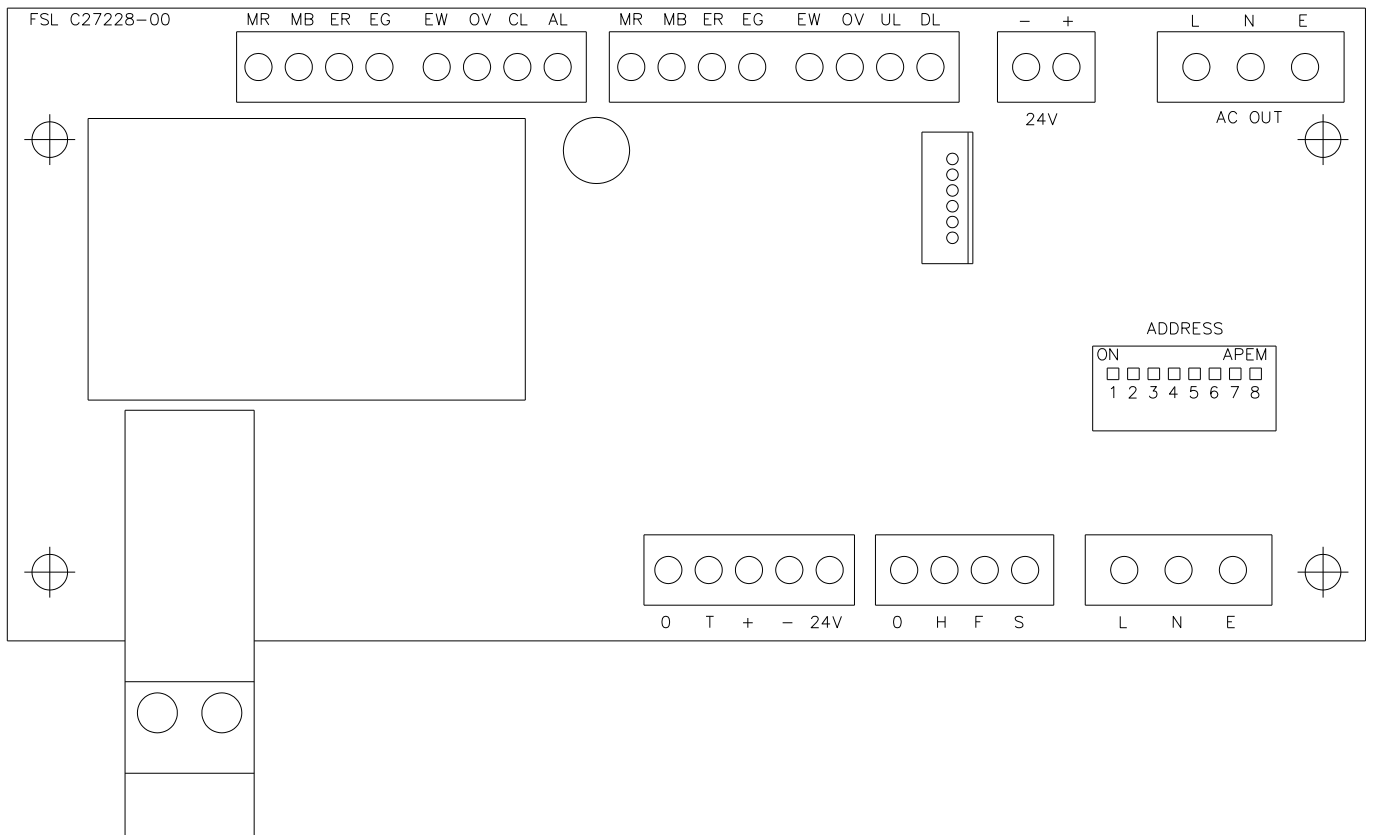

# CONNECTIONS TO FBUS JOYSTICK CONTROL PANEL

## FBUS CONNECTOR

- 0 OV Supply Input
- T Line Terminate (Connect to + for terminate)
- + FBUS + RS485 Data In/Out
- FBUS - RS485 Data In/Out
- 24 +24V Supply Input

## JOYSTICK CONNECTOR

- BK Joystick Black Wire
- Y Joystick Yellow Wire
- BL Joystick Blue Wire
- R Joystick Red Wire

## FBUS JOYSTICK CONTROL BOARD

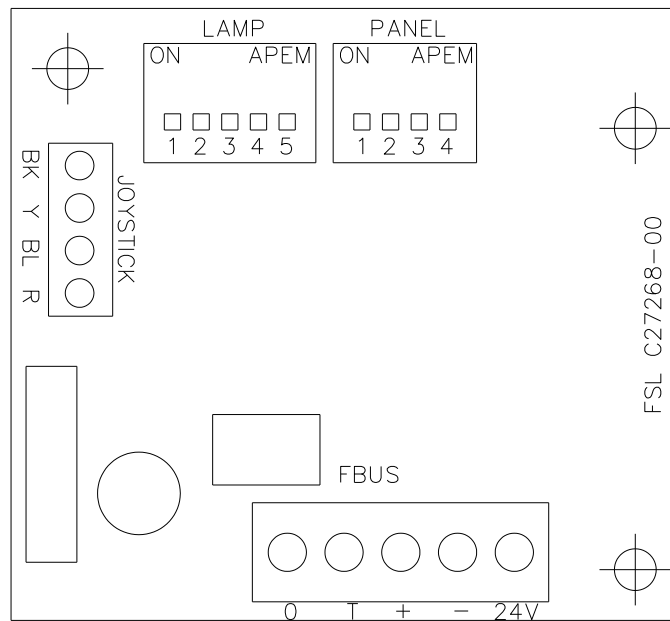

## **FBUS ADDRESS SWITCHES**

### OVERVIEW

FBUS uses two types of address switch. One type is rotary, and the value selected is the value shown on the dial. The other type is rows of switches whose operation is described below: -

The switches all operate in the same manner producing a binary value with the highest binary value to the left and the lowest value to the right. The values for each switch are listed below: -

### **SPEED CONTROL CARD LAMP ADDRESS**

SWITCH NUMBER	VALUE
SWITCH 4	16
SWITCH 5	8
SWITCH 6	4
SWITCH 7	2
SWITCH 8	1

### **STANDARD CONTROL PANEL – LAMP ADDRESS**

SWITCH NUMBER	VALUE
SWITCH 1	16
SWITCH 2	8
SWITCH 3	4
SWITCH 4	2
SWITCH 5	1

### **STANDARD CONTROL PANEL – PANEL ADDRESS**

SWITCH NUMBER	VALUE
SWITCH 1	8
SWITCH 2	4
SWITCH 3	2
SWITCH 4	1

Switching a switch to on, adds the binary value relating to that switch to the address value. With all switches off the value is zero.



## EXAMPLES

Standard control panel – panel address set to 5

Switch 1 = Off

Switch 2 = On (Value 4 added to address)

Switch 3 = Off

Switch 4 = On (Value 1 added to address)

$4 + 1 = 5$

Speed control card - lamp address set to 11

Switch 4 = Off

Switch 5 = On (Value 8 added to address)

Switch 6 = Off

Switch 7 = On (Value 2 added to address)

Switch 8 = On (Value 1 added to address)

$8 + 2 + 1 = 11$

## ADDRESSING SYSTEM

The addressing system is very simple. Every lamp must have a unique address. The addresses should be sequential and should start from zero. If there were three lamps in a system the addresses should be set to 0, 1 and 2.

Control panel – panel addresses use the same system being sequential and start from zero.

It is essential that all lamp have a unique address with no duplication.

It is essential that all panels have a unique address with no duplication however note that lamps and panels can be the same address. For example, on a system with two panels and two lamps, the panel addresses will be 0 and 1 and the lamps addresses will be 0 and 1.

Control panel lamp addresses are defined by the system configuration. If two panels are used to control the same lamp they must still have individual panel addresses but the lamp addresses can be set to the same address value as the lamp which is to be controlled. Any number of panels can control the same lamp.

# **FBUS DATA PROTOCOL**

## **OVERVIEW**

The Francis bus (FBUS) is a custom communication protocol based on RS485 two wire bi directional communication hardware. The system provides a simple bi-directional link between lamps and lamp control panels. The system allows given panels to communicate with different lamps and also allows a number of panels to communicate with the same lamp.

## **DETAILED DESCRIPTION**

The FBUS system runs at 38.4K Baud. This low data rate facilitates longer cable runs and complements the fairly small amount of data transfer required whilst still providing a fast response. The data frame is 11 bits with 9 data bits, one start and one stop bit. A simple error detection system is employed which is described in detail later. Data is sent LSB first.

To prevent data collisions the system uses a polling technique. Lamp number 0 is the default bus master and controls timing of all communications by polling other units connected to the bus. If lamp 0 is not operating or powered down, lamp 1 automatically becomes the bus master as will lamp 2 if lamp 1 is not operating.

The system differentiates between address and data values by setting data bit 8 high for an address. Panel 2 address would therefore be sent as hex 102 or binary 100000010. The lamps and panels use different address ranges with panels being addresses 0-15 and lamp addresses starting at 16 and going up to 56. A lamp whose address was set to 0 on the address switches will actually, be address 16 and would be transmitted as hex 110 or binary 100010000.

If lamp 0 is active this becomes the bus master and sequentially transmits the full address range. No other units will transmit until they receive their address. Each address is followed by a 1mS dead period where the master switches from transmit to receive and monitors the bus for activity. If activity is present the master will not transmit the next address until 1mS after bus activity ceases. After the full panel address range has been sent (addresses 0-15) the master starts to send lamp addresses.

These operate slightly differently in that, if more than three successive addresses do not illicit a response, the bus master will assume the last lamp has been polled and re starts the data cycle by reverting to panel address 0. When a remote panel receives its address, it will send data if it has any to send, if not, no data will be sent. Lamps operate differently in that they will always send data after they have seen their address on the bus. Panels can send data to any lamp therefore they transmit a modified lamp address value prior to the lamp command(s). The modified address is received by lamps and, if it matches their own address, the command(s) which follow will be received and processed.

A detailed description of panel and lamp data follows.

## **PANEL TRANSMITTED DATA**

Panels only send data when there is data to be sent i.e. there has been activity at the panel which must be sent to a given lamp. If there is no data to be sent, a panel will not transmit. The amount of data a panel sends will depend upon the amount of activity at the panel and can be 2 to 10 bytes. The commands described below are sent after a panel receives its address which it uses as indication that it has a transmit time slot. Before any commands are sent the panel must define which lamp the data pertains to. This is achieved by preceding the command with a lamp address. Note that bit 7 is not set when a panel defines the lamp to which it is to transmit. Lamps recognise the address and receive data when the address matches their own. To send commands to lamp number 2 a panel would precede the lamp command(s) with the address value Hex 2, Binary 00000010. It is important to note that multiple commands must be sent in numerical order i.e. a command with value 01 must be sent before a command with 06 etc.

Panel transmit commands are listed below; -

### **DATA\_PAN\_JOYSTICK (Hex 01)**

This is a two-byte command and must be immediately followed by another byte whose value determines the lamps direction and speed. The value is centred on 128 and has a range of 128 +/- 64. A value of 130 will make the lamp rotate slowly clockwise. Increasing the value will make the lamp move faster. A value of 126 will make the lamp rotate slowly anticlockwise. Decreasing the value will make the lamp move faster. Transmitting values 01 then C0 would make the lamp pan clockwise at full speed.

### **DATA\_TILT\_JOYSTICK (Hex 02)**

This is a two-byte command and must be immediately followed by another byte whose value determines the lamps direction and speed. The value is centred on 128 and has a range of 128 +/- 64. A value of 130 will make the lamp point upwards slowly. Increasing the value will make the lamp move faster. A value of 126 will make the lamp move down slowly. Decreasing the value will make the lamp move faster. Sending values 02 then C0 would make the lamp tilt up at full speed.

### **DATA\_LAMP\_BUTTON (Hex 0A)**

This is a single byte command. The same command is sent to switch the lamp on or off. This command must only be sent once for each press of the button. Sending again will switch the lamp again. Basically, if the lamp was off, sending this value will switch it on. If the lamp was on, sending this value will switch it off. This technique is employed to facilitate simultaneous lamp control from a number of different panels. Basically, what is sent is just information that the lamp on off button has been pressed. How the lamp reacts to this depends on the lamps current status. Most of the other lamp button commands operate in a similar manner except the focus button. Confirmation that the command has been received can be obtained by reading the lamp status byte described below.

### **DATA\_FOCUS\_BUTTON (Hex 0B)**

This is a single byte command. When the lamp receives this, it will run the focus motor as long as the command remains. A panel will send this command so long as the focus button is pressed.

### **DATA\_HOME\_BUTTON (Hex 0C)**

This is a single byte command. A lamp receiving this will automatically move to the pre-set home position. The command does not need to be maintained while the lamp moves to home.

### **DATA\_RECORD\_BUTTON (Hex 0D)**

This is a single byte command. The first time a lamp receives this command it will enter record mode and start monitoring all movement and lamp switching information. Recording will continue until the command is received again when it will stop recording. As with most of the button commands it is essential this command is just sent once. Confirmation that the command has been received can be obtained by reading the lamp status byte described below.

### **DATA\_PLAY\_BUTTON (Hex 0E)**

This is a single byte command. The first time this is received a lamp will start playing back any movement / lamp switching activities which were recorded using the record function above. This will continue until the command is received again or the lamp receives a move command (DATA\_PAN\_JOYSTICK or DATA\_TILT\_JOYSTICK).

### **DATA\_HOME\_LP (Hex 0F)**

This is a single byte command which activates when the home button is pressed and held for 5 seconds (Home Long Press). This is used to store a new home position. A lamp receiving this command will store the current position as the value to move to when the home button is pressed normally. Note that a lamp can only receive up to 10 bytes at a time. A panel's transmit sequence is the modified receiving lamp address followed by data commands then the CRC. The CRC is formed by the sum of all the commands + the lamp address value – note however that the address value used in the CRC is the unmodified value (Bit 7 clear).

### **DATA\_PAN\_POSITION (Hex 18)**

This is a three-byte command. Following the DATA\_PAN\_POSITION command two data bytes specify the position to which the lamp must move. The bearing resolution is 0.1 degrees. The value is sent LSB first with the first byte representing the lower position command bits. The MSB (sent last) lower 4 bits represents the remaining value. The position value is centred on 2048 (Binary 1000 0000 0000) so a value of 2048 would make the lamp move to the dead ahead position. An increasing value represents a clockwise motion with a resolution of 0.1 degrees. A value of 2058 would therefore represent 1 degree clockwise (2058 = 2048 + 10 – but resolution is 0.1 degrees so a value 10 = 1 degree). Values below 2048 represent anticlockwise motion so a value of 1048 would represent an angle 100 degrees anticlockwise of centre.

### **DATA\_TILT\_POSITION (Hex 19)**

This is a three-byte command. Following the DATA\_TILT\_POSITION command two data bytes specify the position to which the lamp must move. The bearing resolution is 0.1 degrees. The value is sent LSB first with the first byte representing the lower position command bits. The MSB (sent last) lower 4 bits represents the remaining value. The position value is centred on 2048 (Binary 1000 0000 0000) so a value of 2048 would make the lamp move to the dead ahead position. An increasing value represents tilting up with a resolution of 0.1 degrees. A value of 2058 would therefore represent 1 degree up from dead ahead ( $2058 = 2048 + 10$  – but resolution is 0.1 degrees so a value  $10 = 1$  degree). Values below 2048 represent tilting down so a value of 1748 would represent an angle 30 degrees down from centre.

### **LAMP TRANSMITTED DATA**

A given lamp after it receives its normal address (Hex 110 to Hex 138) will always send the following data in this specific order. The lamp must transmit its first data byte (pan position) within 1mS of receiving its standard address and the gaps between successive bytes must be less than 1mS.

Lamp TX Byte 1 – Pan position LSB  
Lamp TX Byte 2 – Pan position MSB  
Lamp TX Byte 3 – Tilt position LSB  
Lamp TX Byte 4 – Tilt position MSB  
Lamp TX Byte 5 – Lamp status  
Lamp TX Byte 6 – CRC

Each byte is described below

#### **Pan Position**

This is a 12-bit value with lamp pointing straight ahead being a value of 2048 and the value increasing as the lamp rotates clockwise as viewed from above. The system has a resolution of 0.1 degrees so 90 degrees clockwise from centre would be a value of 2948 ( $2048 + 900$ ).

#### **Tilt position**

This is a 12-bit value with lamp horizontal being a value of 2048 and the value increasing as the lamp beam points up. This has a resolution of 0.1 degrees.

#### **Lamp Status**

This is an 8-bit value with each bit representing a specific status aspect. The bit functions are listed below; -

Bit 0 - Lamp on  
Bit 1 - Pan Limit reached  
Bit 2 - Tilt Limit reached  
Bit 3 - Lamp Recording  
Bit 4 - Lamp Playing  
Bit 5 - Lamp Overheated  
Bit 6 - Lamp moving to home  
Bit 7 - Reserved

The bits are all true logic so if the lamp is switched on, bit 0 will be high.

## **CRC**

The CRC is a simple data checking system. Basically, this is just the sum of the lamps address and bytes above. The value is radix to 8 bits. If the lamp address was 0 (bus address value 16) and the pan and tilt were both at centre and the lamp was switched on and all other status bits were 0 the values would be Hex 110, 80, 80, 01. This would give a CRC value of 11.

Each lamp connected to the bus will always send the data sequence above after it detects its address on the bus. This is basically broadcast information which will be picked up by any panel whose lamp address value matches the currently transmitting lamp address. In this way a panel, which can access more than one lamp, will always update to reflect the status of the currently selected lamp more or less instantly.

## **EXTERNAL INTERFACE TO LAMPS**

Interfacing to FBUS is simple. Any external interface must act as a slave and only send data when given an address slot. The address of an external interface can be any of the panel addresses providing these are not in use by other panels connected to the bus. To receive data from a lamp simply wait for the specific lamps address to be present on the bus then load the next six bytes which will comprise the lamps transmitted data as described above. A detailed description of transmitting and receiving is described below.

## **TRANSMITTING TO A LAMP**

Basically, any sending device mimics a control panel. The full range of panel transmit commands, as described above, can be employed. Data can be sent to any lamp on the system. Two transmit examples are listed below.

### **EXAMPLE 1**

Sending a lamp on/off command using panel 0 address and sending to lamp address 0. Note that the lamp will change switched state each time this command is sent therefore this should only be sent once.

1. Wait for panel address 0 (Hex 100) to be received from the bus.
2. Transmit lamp 0 address (Hex 110) within 1mS. Lamp address 0 is physical address 16 (Hex 10). When a panel sends to a lamp bit 8 is set (hex 100).
3. Send DATA\_LAMP\_BUTTON Command (Hex value 0A) within 1mS.
4. Send CRC value, in this case Hex 110 + Hex 0A = 11A after radix to 8 bits = 1A. This completes the transmission

### **EXAMPLE 2**

Sending a half speed pan clockwise command using panel 1 address and sending to lamp address 6. – Note that in this example the lamp will continue to pan as long as the command is repeated.

1. Wait for panel address 1 (Hex 101) to be transmitted by the master.
2. Transmit lamp 6 address (Hex 16) within 1mS. Lamp address 6 is physical address 22 (Hex 16).
3. Send DATA\_PAN\_JOYSTICK Command (Hex value 01) within 1mS.

4. Send pan value half speed =  $128 + (64/2) = \text{Hex A0}$  within 1mS.
5. Send CRC value, in this case Hex 116 + Hex 01 + Hex A0 = 1D7 after radix to 8 bits = B7.
6. This completes the transmission

### **RECEIVING FROM A LAMP**

Lamps broadcast data sequentially. There is no need to actively request data to be sent, just wait for the lamps address with bit 7 set to be present on the bus and load the next six bytes. An example is given below; -

### **EXAMPLE**

Obtain lamp number 2 pan position.

1. Listen to the data bus and wait for value Hex 112. (Lamp addresses start at hex 10 so lamp 2 is value 12. Addresses always have bit 8 set so total value is Hex 112).
2. Load the next six bytes from the bus.
3. If desired check the last of the six bytes which is the CRC.
4. Read the two bytes which will be a value centred on 2048 increasing for clockwise from centre and decreasing for anticlockwise. This is lamp number 2 current pan position.

## **FBUS Speed Control Assembly Status LED Operation**

### Overview

The FBUS motor control card has a status LED near the centre of the card (labelled 'STATUS'). This has a number of functions as detailed below.

### **SOFTWARE VERSION**

When power is applied to the speed control card the status LED will flash green. The number of flashes corresponds to the software version.

### **FBUS NORMAL OPERATION**

When the system is operating from FBUS the status LED will illuminate static green. When a valid FBUS data signal is received the LED will switch off momentarily to indicate data reception. If data is continuous the LED will flash green slowly.

### **DMX NORMAL OPERATION**

When the system is operating from DMX the status indicator will flash green slowly when DMX data is present. If no DMX data is present the LED will be static green.

### **OPERATION DURING FAULTS**

During faults normal status LED operation is overridden. The status LED will flash red a number times with the number of flashes corresponding to the specific fault. If there are multiple faults the LED will flash accordingly with a gap between each fault flash sequence. Fault details are provided below with the number of flashes indicated on the left.

1. Pan Limit. – Either of the pan limit switches operated. Note that this may not actually be a fault. The LED will flash when a limit switch is operated under normal circumstances i.e. the lamp is at the limit of travel. This will also indicate when a variable limit is reached.
2. Tilt Limit. – Either of the tilt limit switches operated. Note that this may not actually be a fault. The LED will flash when a limit switch is operated under normal circumstances i.e. the lamp is at the limit of travel. This will also indicate when a variable limit is reached.
3. Pan motor over current. – The pan motor is taking excessive current. The motor will be disabled for a period when this occurs. Fault indication will remain until power is removed or the fault is corrected.
4. Tilt motor over current. – The tilt motor is taking excessive current. The motor will be disabled for a period when this occurs. Fault indication will remain until power is removed or the fault is corrected.
5. Focus motor over current. – The focus motor is taking excessive current. The motor will be disabled for a period when this occurs. Fault indication will remain until power is removed or the fault is corrected.
6. FBUS interface over current. – The speed control card supplies 24VDC to the remote-control panels. This fault indicates the 24VDC output is taking excessive current. The FBUS supply output will switch off. To restore this output, remove the supply from the speed control card for a period.
7. Anti-condensation heater output over current. – The 24VDC anti condensation heater output is taking excessive current. The heater output will switch off. To restore this output, remove the supply from the speed control card for a period.
8. Limit Switch Error. Some lamp types do not use all or some limit switches. If an invalid limit switch input is detected it is probable the speed control card is set to the wrong product or there is a wiring error.
9. Datum Error. The start-up datum system has not completed correctly.
10. Product type not set or corrupt. The product type has not been set, has been set incorrectly or is corrupt.
11. Supply voltage out of tolerance. The 24V supply is outside the range 18-30V.



## **FBUS INTERFACE UNIT (if supplied)**

### **OVERVIEW**

Francis Searchlights FBUS system is designed to allow multiple control panels to manage a number of searchlights on a common data cable. The data system is application specific and, as such, has a fixed data rate and complex timing. The FBUS interface offers a simplified and less time constrained communication interface to the FBUS system over a number of different physical layer communication standards and data rates.

### **POWER / CONNECTIONS**

The interface draws a supply from the FBUS, no external power supply is required. The interface connects to the four-wire FBUS system like any other FBUS system component. The four-wire interface provides a 24V supply and RS485 communications with FBUS.

Connection to the external interfaces will depend on the user's choice of communication system. RS422 (4-wire) RS485 (2-wire) and RS232 are all provided. The RS422 OUT / IN legend on the PCB refers to the data direction from the perspective of the interface unit. The OUT terminals are the interface unit transmit connections. The RS232 connector is configured as a DCE and has all handshake lines looped. No flow control is required. The connections are listed below; -

1. Line signal detect (linked to pins 4 and 6)
2. TX out
3. RX in
4. DTE (linked to pins 1 and 6)
5. 0V
6. DCE Ready (linked to pin 1 and 4)
7. CTS (linked to 8)
8. RTS (linked to 7)
9. No Connection

### **OPERATOR INTERFACE**

The operator interface is very simple with four buttons controlling a single layer menu system on a 2-line LCD display. A given menu item is selected with the SEL (select) button. If the menu item has an adjustable parameter this can be altered using the up and down arrow keys. The revised parameter is stored using the ENT (enter) button. A list of the menu items is provided below; -

### **MENU ITEMS**

#### **DEFAULT DISPLAY**

The default display will be active from switch on until the select button is pressed. The default display has no adjustable parameters. The display top line shows the FBUS status. If FBUS is functioning correctly the display top line will show FBUS-ON. The top line of the display also shows the currently selected lamp status i.e. on or off. The default display will indicate if the currently selected lamp is active or not. If the FBUS is working and the

currently selected lamp is responding the bottom line of the display will show the current pan and tilt angles.

#### SET PANEL ADDRESS

The FBUS interface looks like a standard control panel to the FBUS as such it must have a panel address. The panel address must not be set to the same value as any other panel on the system. Panel addresses start at 0 and go up to 15. Panel addresses should be sequential and start from zero. Once set pressing ENT stores the address.

#### SET LAMP ADDRESS

The interface unit has menu items (described below) which send commands directly to a given lamp. The default display described above displays data from a given lamp. The set lamp address item is used to define the 'given lamp' address. Lamp addresses start at 16 and go up to 40. This range equates to lamp 0-24 on the lamps address switches.

#### SET COMMS TYPE

This menu item selects the physical layer communication system for the external interface.

#### SET DATA RATE

This item selects the data rate for the external interface.

#### SET DATA CHECKING

This is used to enable or disable received data checking for the external interface. Switching data checking off can be useful during external interface development. Note that this does not affect data checking transmitted to the external interface from the interface unit and does not affect FBUS data checking.

#### SWITCH LAMP

This is one of the local functions included principally to aid external interface development and verify correct FBUS / lamp operation. Use the arrow keys to select lamp on or lamp off from line 2 of the display. Pressing ENT will send the on or off command to the currently selected lamp (see set lamp address).

#### SET PAN ANGLE

This command sends a move to pan position command to the currently selected lamp. The pan angle is set using the arrow keys. Pressing enter will make the lamp move to the displayed angle.

#### SET TILT ANGLE

This command sends a move to tilt position command to the currently selected lamp. The tilt angle is set using the arrow keys. Pressing enter will make the lamp move to the displayed angle.

## FOCUS

This function is not implemented on all searchlights. Focus displays the current focus position with a value of 0-100. A value of 50 should represent the most focused beam with the beam diverging above and below 50. Note that the value will ascend from 0-100 the reset back to 0.

Pressing the arrow up button will operate the focus motor.

## FAULTS+LIMITS

This displays any faults or limit switch activation relating to the selected lamp. Multiple faults will be displayed sequentially.

## LAMP SOFTWARE

This displays the software version of the currently selected lamp

## LAMP TYPE No

This displays the lamp type number.

## EXT COMMS DATA

This item is included to aid external interface development. The display bottom line will show any valid received commands preceded by the lamp number to which the command is sent. If data checking is enabled the display will indicate if there is a CRC error. The system will also indicate if there has been a bad lamp address or if the command sent is not valid.

## FBUS SUPPLY

This just indicates the FBUS supply voltage. FBUS operates at 24V. Values above 30 or below 18 indicate something is wrong.

## **EXTERNAL DATA INTERFACE – RECEIVED COMMANDS**

The external data interface uses command data packets with between four and six bytes including the CRC.

The system uses standard 8-bit data transfer with 1 start bit and 1 stop bit. Data is sent least significant bit (LSB) first.

All data transfer is initiated by the user therefore the system will be inactive until a user transmission.

All data reception must start with a sync byte. The sync byte is value 0xFF.

The next byte is the lamp address. The lamp address is a value between 0x90 and 0xA8. Lamp 0 address would therefore be sent as 0x90. The lamp address indicates which lamp on the system the remaining data is to be directed to.

The next byte is the lamp command. Lamp commands are detailed below. Some lamp commands have subsequent data bytes.

## DATA\_FOCUS (0x0B)

This is a four-byte command (Sync, Lamp address, command, CRC). A lamp receiving this will operate its focus motor momentarily. To keep the focus motor running the command must be sent repeatedly.

#### DATA\_MOVE\_TO\_HOME (0x0C)

This is a four-byte command (Sync, Lamp address, command, CRC). A lamp receiving this will automatically move to the pre-set home position. The command does not need to be maintained while the lamp moves to home. If a home position has not been defined the home position will be straight ahead with the lamp horizontal.

#### DATA\_STORE\_HOME (0x 0F)

This is a four-byte command (Sync, Lamp address, command, CRC). A lamp receiving this will store the current pan and tilt position values and will move to these values when the DATA\_MOVE\_TO\_HOME command is issued.

#### DATA\_PAN\_CLOCKWISE (0x14)

This is a five-byte command (Sync, Lamp address, command, speed, CRC)  
The speed value is between 0 and 127. Value 0 stops pan motion. Increasing values make the lamp move progressively faster. Transmitting codes 0xFF 0x90 0x14 0x7F would make lamp 0 move full speed clockwise.

#### DATA\_PAN\_ANTICLOCKWISE (0x15)

This is a five-byte command (Sync, Lamp address, command, speed, CRC)  
The speed value is between 0 and 127. Value 0 stops pan motion. Increasing values make the lamp move progressively faster. Transmitting codes Hex 0xFF 0x90 0x15 0x7F would make lamp 0 move full speed anticlockwise.

#### DATA\_TILT\_DOWN (0x16)

This is a five-byte command (Sync, Lamp address, command, speed, CRC)  
The speed value is between 0 and 127. Value 0 stops tilt motion. Increasing values make the lamp move progressively faster. Transmitting codes Hex 0xFF 0x92 0x16 0x7F would make lamp 2 move down at full speed.

#### DATA\_TILT\_UP (0x17)

This is a five-byte command (Sync, Lamp address, command, speed, CRC)  
The speed value is between 0 and 127. Value 0 stops tilt motion. Increasing values make the lamp move progressively faster. Transmitting codes Hex 0xFF 0x92 0x17 0x7F would make lamp 2 move up at full speed.

#### DATA\_MOVE\_TO\_PAN\_POSITION (0x18)

This is a six-byte command (Sync, Lamp address, command, position LSB, Position MSB, CRC). The position value is 12 bits and gives a resolution of 0.1 degrees. The most significant byte (sent last) comprises the top 5 bits. The most significant bit (bit 4 – 0b0000x000) determines whether the pan angle is positive (clockwise of centre) or negative (anticlockwise of centre) Bit 4 set to 1 indicates angle is clockwise. The remaining bits will increment as the lamp moves from centre in either direction. The least significant byte comprises the lower 7 bits of the value with the most significant bit set to zero.  
As an example, a value of 0x0A followed by 0x08 would indicate an angle 1 degree clockwise of centre. 0x0A = 10 but resolution is 0.1 degrees so divide integer value by 10 to give 1.0 degrees. A value of 0x64 followed by 0x00 would indicate a value of 10 degrees anticlockwise of centre.

#### DATA\_MOVE\_TO\_TILT\_POSITION (0x19)

This is a six-byte command (Sync, Lamp address, command, position LSB, Position MSB, CRC). The position value is 12 bits and gives a resolution of 0.1 degrees. The most significant byte (sent last) comprises the top 5 bits. The most significant bit (bit 4 – 0b0000x000) determines whether the tilt angle is positive (tilted up relative to straight ahead) or negative (tilted down relative to straight ahead). Bit 4 set to 1 indicates angle is tilt up. The remaining bits will increment as the lamp moves from centre. The least significant byte comprises the lower 7 bits of the value with the most significant bit set to zero. As an example, a value of 0x0A followed by 0x08 would indicate an angle 1 degree up of centre. 0x0A = 10 but resolution is 0.1 degrees so divide integer value by 10 to give 1.0 degrees. A value of 0x64 followed by 0x00 would indicate a value of 10 degrees down of centre.

#### DATA\_LAMP\_ON (0x1A)

This is a four-byte command (Sync, Lamp address, command, CRC). The lamp will switch on when this code is received.

#### DATA\_LAMP\_OFF (0x1B)

This is a four-byte command (Sync, Lamp address, command, CRC). The lamp will switch off when this code is received.

#### DATA\_RECORD (0x0D)

This is a four-byte command (Sync, Lamp address, command, CRC). The lamp will start recording motion and lamp on / off data when this code is received.

#### DATA\_PLAY (0x0E)

This is a four-byte command (Sync, Lamp address, command, CRC). The lamp will start playing back a previously recorded sequence when this code is received.

#### DATA\_REQUEST\_LAMP\_STATUS (0x1E)

This is a four-byte command (Sync, Lamp address, command, CRC). When the interface receives this command, there is a 10mS delay then the interface will switch to transmit and send 13 bytes as detailed below.

1. Sync (FF)
2. Lamp Address with bit 7 set - range 0x90-0xA8
3. Pan Position LSB (Same format as pan position command above)
4. Pan Position MSB
5. Tilt Position LSB (Same format as tilt position command above)
6. Tilt Position MSB
7. Lamp Status
  - Bit 0 - Lamp on
  - Bit 1 - Pan Limit reached
  - Bit 2 - Tilt Limit reached
  - Bit 3 - Lamp Recording
  - Bit 4 - Lamp Playing
  - Bit 5 - Lamp Overheated (not currently implemented)
  - Bit 6 - Lamp moving to home

8. Focus position - Value between 0 and 100 - finest focus at value 50.

9. Fault Status 1

- Bit 0 - Pan motor current high.
- Bit 1 - Tilt motor current high.
- Bit 2 - Focus motor current high.
- Bit 3 - FBUS +24V out current high.
- Bit 4 - Heater current high.

10. Fault Status 2

- Bit 0 - Limit switch error.
- Bit 1 - Datum error.
- Bit 2 - Lamp type invalid.
- Bit 3 - Supply voltage out of tolerance.

11. Lamp software version.

12. Lamp type No.

13. CRC

### **ERROR CONTROL**

Error control is supported by a CRC following each data packet. The CRC is radix to 7 bits with a value between 0 and 127. The CRC is simply the addition of all packets data values including the address and start byte (0xFF). For example, if lamp 0 were commanded to run its focus motor the transmitted data would be; -

0xFF, 0x90, 0x0B. The addition of these values gives 0x19A. The CRC would therefore be this value radix to 7 bits to give a value of 0x1A. this value is the CRC and would be sent as the last byte of the packet.

### **DATA TIMING**

Data packets can be sent up to 10 times per second. Each packet starts with the lamp address which is the only value with bit 8 set. The remaining bytes should follow immediately. The whole packet must be received within 30mS. A packet lasting longer than 30mS will be rejected.

There is no minimum packet send rate. If there is no new data, the system will remain idle.

When the interface unit receives the DATA\_REQUEST\_LAMP\_STATUS command there is a 2-30mS delay after which the interface will switch to transmit and output the 5 data bytes in direct succession. After the last byte has been sent the interface will switch back to receive almost immediately.

## 7- Fault Finding

All fault finding must be conducted by a competent person or qualified Electrical Engineer.

### **Failure of Lamp to ignite**

In the event of the lamp failing to light the following steps should be taken:

- 1) Check the supply fuse.
- 2) Check 24v dc supply in the junction box across terminals + & -.
- 3) Replace lamp if still fails to ignite replace the ballast/igniter unit.

### **Failure of Remote Focus**

*Causes:*

- 1) Power not supplied;
- 2) Faulty connections;
- 3) Failed motor;

*Remedy:*

- 1) Check voltage at supply and the output from the control board in the searchlight. If no supply present fault is at customer supply or speed controller board. If power is present, see remedy 2;
- 2) Check all wiring connections on motor in accordance with the wiring diagram. If found to be correct, see remedy 3;
- 3) Remove the focus motor and apply 24v DC directly across terminals. If motor does not rotate the unit has failed. A new focus motor should be fitted.

## 8 - Maintenance and Servicing

In order to prolong the service life and performance of your searchlight, the following maintenance guidelines are recommended:

- Maintenance checks should be conducted before every voyage or at least every three months;
- Before checking, disconnect the equipment from the supply;
- Visually inspect the condition of the equipment;
- Any major or minor structural damage should be rectified immediately in order to reduce sympathetic wear;
- After inspection it may be necessary to clean the inside of the searchlight. The following procedure should be adhered to:
  - Remove the upper casting by removing the five M8 socket bolts with the dubo washer on the underneath of the searchlight,
  - Clean the front glass inside and out using a proprietary glass cleaner;
  - Clean the reflector if required;
  - Check earth point for conductivity;
  - It is advisable to check all seals and gaskets for signs of degradation. Renew if necessary;
  - The searchlight is fitted with a breather unit. This ensures a steady airflow in order to prevent any vacuum forming within the barrel.
  - Upon completing all maintenance requirements, the searchlight should be tested for full working order (approximately 20 minutes).

**If in any doubt as to the correct servicing procedures to adopt, please contact your distributor/agent or the manufacturer who will be able to advise the best course of action for your product.**



## 9 - Wiring Diagrams and General Assembly

<b>Drawing Number</b>	<b>Description</b>
A7180	A7186 VX500RC 100w HID LV GA
C27393	Wiring Diagram 24v Supply
C27312	Control Panel Assembly
C27379	Junction Box Assembly

DATE 11.16	INDICATION DETAILS LV	16
AS FIRST DRAWN		
1		

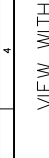
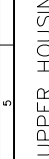
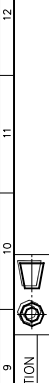
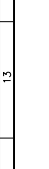
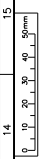

VIEW WITH UPPER HOUSING REMOVED

HALOGEN COMPONENT PLATE IS SHOWN

IN 11 POS'N

IN 2 POS'N

IN 4 POS'N

FIT SEALING STRIP AFTER FITTING THE GLASS TRIM TO SUIT

GLASS LOCATION INDICATOR WEBBS

SEE ADDITIONAL WORK INSTRUCTIONS

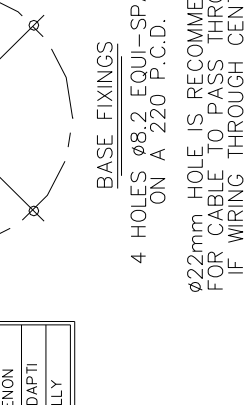
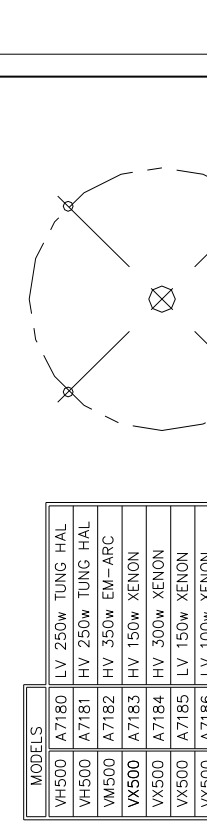

BASE FIXINGS

4 HOLES  $\phi 8.2$  EQUI-SPACED ON A 220 P.C.D.

$\phi 2.2$ mm HOLE IS RECOMMENDED FOR CABLE TO PASS THROUGH IF WIRING THROUGH CENTRE

MODELS	LV 250w TUNG HAL	HV 250w TUNG HAL	HV 350w EM-ARC	HV 150w XENON	HV 300w XENON	LV 150w XENON	LV 100w XENON	HV 100w XENON	HV 350w ADAPTI	HV 350w ALLY
VH500	A7180									
VH500	A7181									
VM500	A7182									
VX500	A7183									
VX500	A7184									
VX500	A7185									
VX500	A7186									
VX500	A7187									
VM500	A7188									
VM500	A7189									

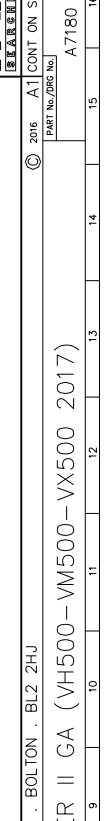
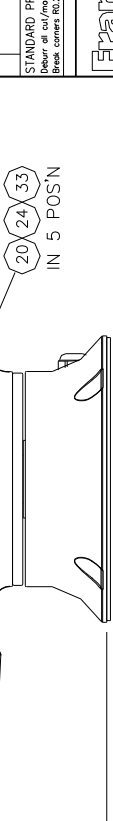
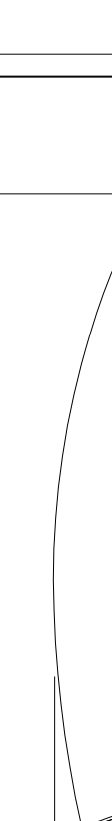
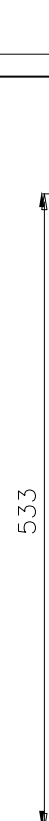

STANDARD PRACTICE Debur all cut/machined edges Break corners R0.25(Min) U.O.S.	16
Francis	
© 2016	
PART No./DRS No.	A1
CONT ON SHEET	
SHT	A7180

DRW	DATE	11.16	16
CHECKED	SCALE	1:2	
ALL DIMENSIONS IN MILLIMETRES	TOLERANCES	General: ±	
	Angular: ±		
	Surface Coating: To ISO 8062 C110		
	Die Coating: To ISO 8682 C18		
	Hole centres & points: ±		

FRANCIS SEARCHLIGHTS LIMITED · UNION ROAD · BOLTON · BL2 2HU	16
DESCRIPTION	
VOYAGER II GA (VH500-VM500-VX500 2017)	



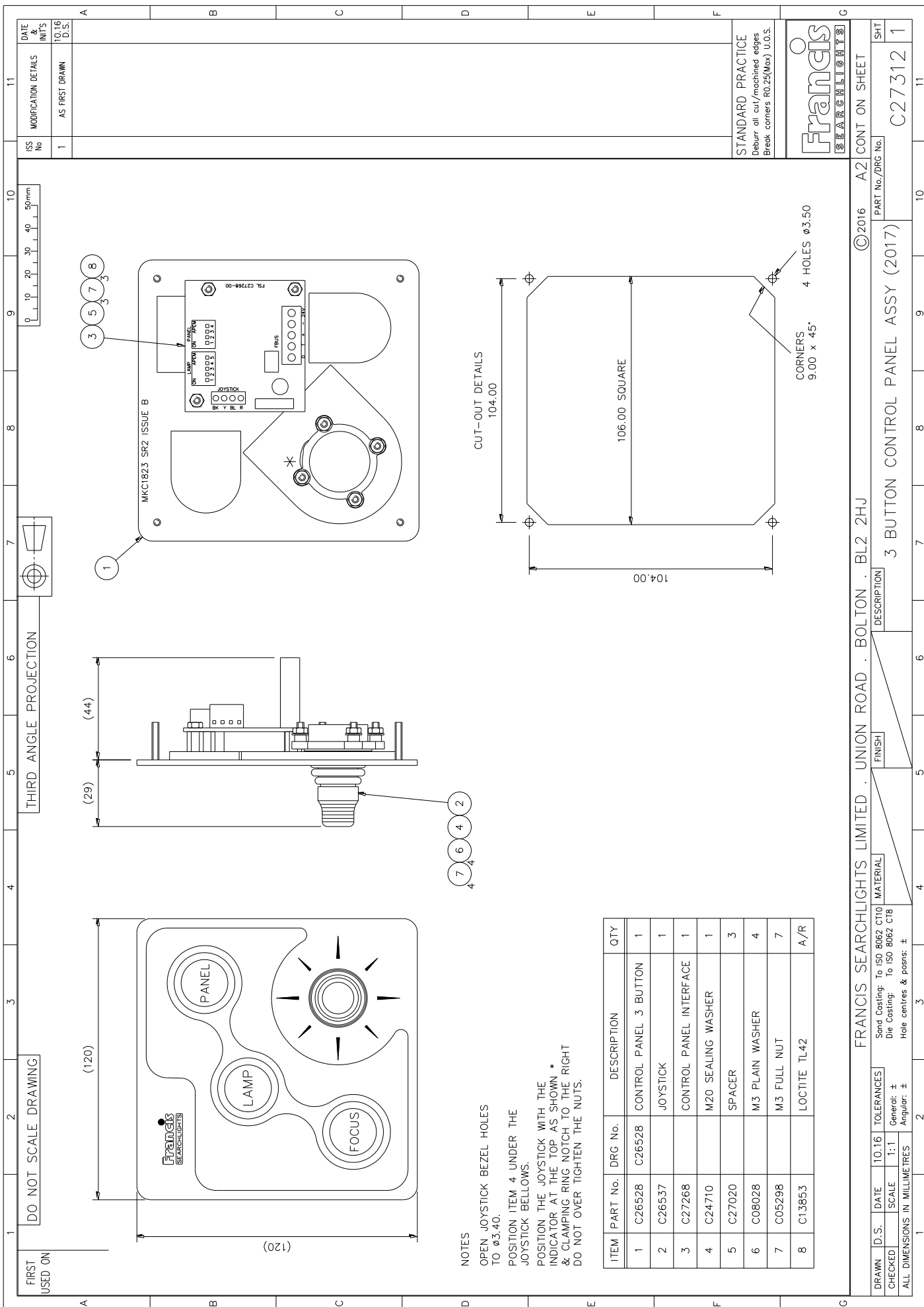

DO NOT SCALE DRAWING

FIRST USED ON

THIRD ANGLE PROJECTION

50mm

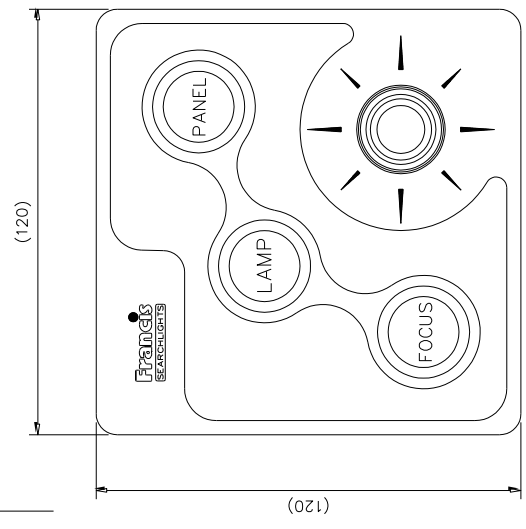
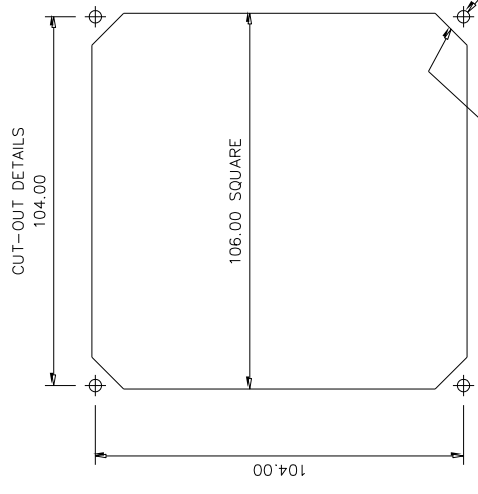
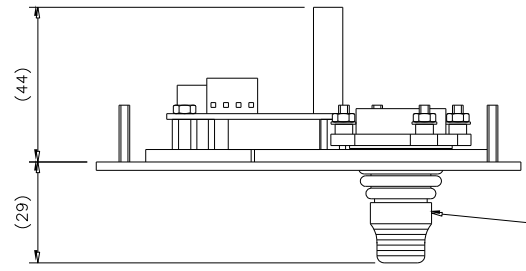
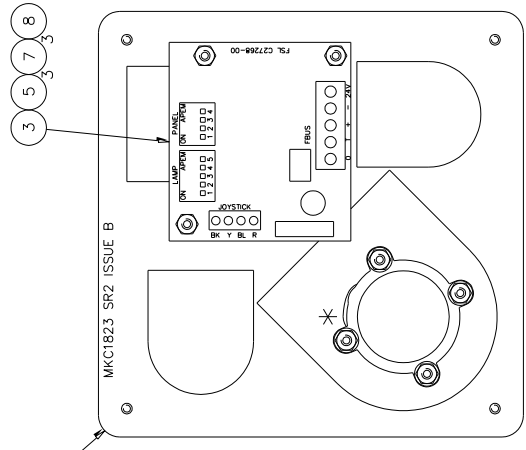

NOTES  
 OPEN JOYSTICK BEZEL HOLES TO  $\phi 3.40$ .  
 POSITION ITEM 4 UNDER THE JOYSTICK BELLOWS.  
 POSITION THE JOYSTICK WITH THE INDICATOR AT THE TOP AS SHOWN \* & CLAMPING RING NOTCH TO THE RIGHT DO NOT OVER TIGHTEN THE NUTS.

ITEM	PART No.	DRG No.	DESCRIPTION	QTY
1	C26528	C26528	CONTROL PANEL 3 BUTTON	1
2	C26537		JOYSTICK	1
3	C27268		CONTROL PANEL INTERFACE	1
4	C24710		M20 SEALING WASHER	1
5	C27020		SPACER	3
6	C08028		M3 PLAIN WASHER	4
7	C05298		M3 FULL NUT	7
8	C13853		LOCTITE TL42	A/R

FRANCIS SEARCHLIGHTS LIMITED · UNION ROAD · BOLTON · BL2 2HJ

DRAWN	D.S.	DATE	10.16	TOLERANCES
CHECKED	SCALE	1:1	General: $\pm$	Angular: $\pm$

FINISH	DESCRIPTION	MATERIAL
	3 BUTTON CONTROL PANEL ASSY (2017)	

ISS No	MODIFICATION DETAILS	DATE & UNITS
1	AS FIRST DRAWN	10.16 D.S.

PART No./DRG No.	SHT
C27312	1

STANDARD PRACTICE  
 Deburr all cut/machined edges  
 Break corners R0.25(Max) U.O.S.

©2016 A2 CONT ON SHEET

Francis SEARCHLIGHTS

FIRST USED ON  
LV 100W A7186  
LV HAL A7180

DO NOT SCALE DRAWING

THIRD ANGLE PROJ

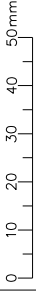

ISS No	1	MODIFICATION DETAILS	AS FIRST DRAWN	DATE & INIT'S	12.16 LW
--------	---	----------------------	----------------	---------------	----------

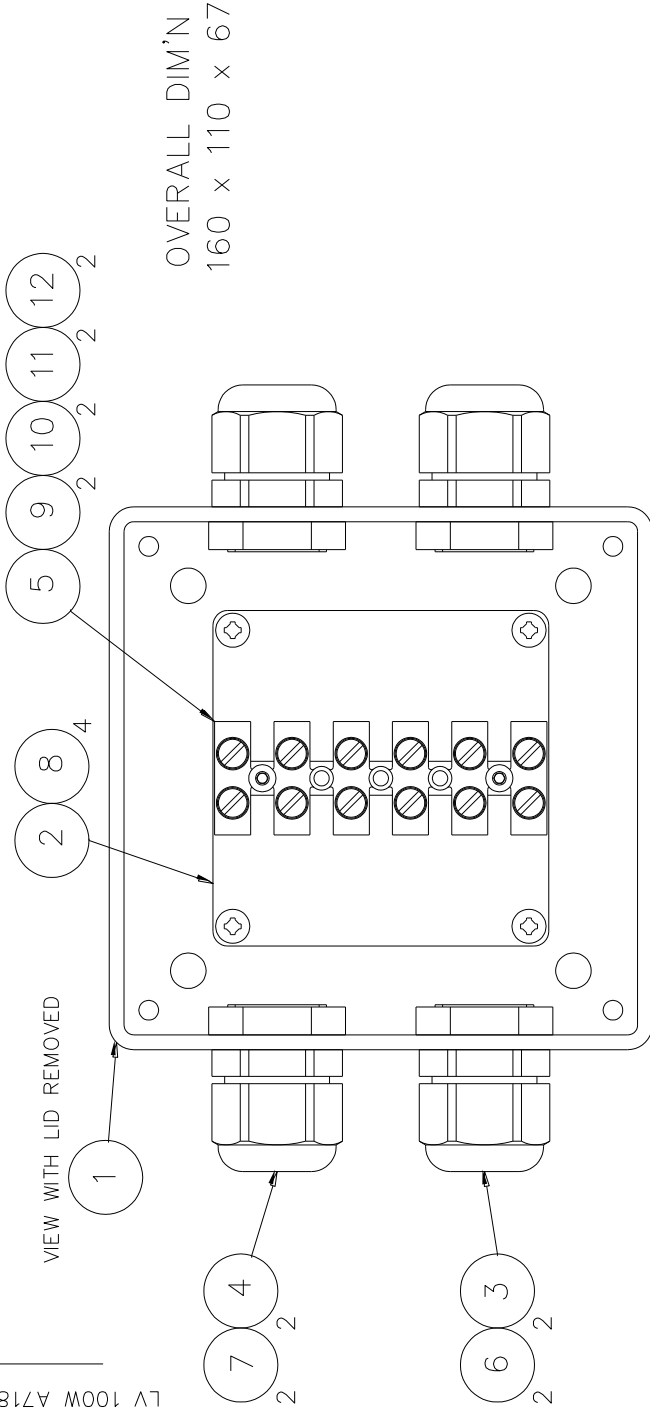

STANDARD PRACTICE  
Deburr all cut/machined edges  
Break corners R0.25(Max) U.O.S.  
TOLERANCES U.O.S: -  
General: ± 0.25  
Angular: ±  
Hole centres & posns: ± 0.125  
Sand Casting: To ISO 8062 CT10  
Die Casting: To ISO 8062 CT8

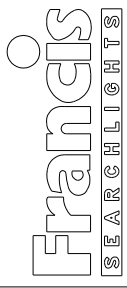

ITEM	PART No.	DRG No.	DESCRIPTION	QTY	ITEM	PART No.	DRG No.	DESCRIPTION	QTY
1	C27442	C27442	ENCLOSURE	1	7	C24827		CABLE 2 PAIR TWISTED 0.22mm	2x 4m
2	C26223	C26223	CHASSIS PLATE	1	8	C23598		SCREW Ø4 x 8 PAN POLYIMATE	4
3	C10158		M20 CABLE GLAND	2	9	C10129		SCREW M3 x 20 BTN HD	2
4	C27121		M20 CABLE GLAND	2	10	C08028		WASHER M3 PLAIN	2
5	C15133		TERMINAL BLOCK (6WAY)	1	11	C10747		WASHER M3 SPRING	2
6	C16778		CABLE 3 CORE 2.5mm	2x 4m	12	C05298		NUT M3 FULL	2

DRAWN LW		DATE	12.16	MATERIAL		FINISH		DESCRIPTION		PART No./DRG No.		SHT
CHECKED		SCALE	1.1					JUNCTION BOX ASSY		C27379		1
ALL DIMENSIONS IN MILLIMETRES												

FRANCIS SEARCHLIGHTS LIMITED. UNION ROAD. BOLTON. BL2 2HJ ©2016 A3 CONT ON SHEET

## 10 - Spare Parts List

The following spare parts can be ordered directly from the manufacturer:

<b>Part Number</b>	<b>Description</b>
<b><u>Searchlight Head</u></b>	
D25858	100w Xenon Lamp
C25857-00	Ballast & Ignitor 100w Xenon
C26139-00	Front Glass
C26184-00	Front Glass Gasket
C26183-00	Sealing Strip Gasket
C26475-00	Mounting Base Gasket
C23808-00	Base 'O' Ring
C16410-00	24v Motor – Focus
C23802-00	Reflector
C22268-01	Breather Assembly
C27158-00	Tilt Motor
C27309-01	Pan Motor Sub Assembly
C27288-00	Resistor (Heater)
C26843-00	Pulley Belt
C27189-01	Speed Controller PCB
C26542-00	Waterproof Cover
C27650-00	Tilt Micro Switch
C25022-00	Proximity Switch (Pan)
C22040-00	Magnet
<b><u>Joystick Panel</u></b>	
C26537-00	Joystick
C27268-00	Joystick Controller PCB

In order to prolong the life and performance of your product, we recommend that you only specify Francis Searchlights spare parts. This will ensure that any warranties on your equipment will not be invalidated.

When ordering spare parts, please contact the Sales Department at Francis Searchlights Ltd. Please quote searchlight model and serial number at all times. This will enable a fast response to your spares' requirements.