



User Instruction & Installation Manual

FX380 Remote Control 1 Kilowatt Xenon Searchlight



Product Reference Number:

A7162 – Variable Speed Motor Unit 240v

A7161 – Variable Speed Motor Unit 115v

Manufacturer's details:

Francis Searchlights Ltd
Union Road, Bolton
Lancashire, BL2 2HJ, UK
Tel: +44 (0) 1204 558960
Fax: +44 (0) 1204 558979
<http://www.francis.co.uk>
E-mail: sales@francis.co.uk

Distributor details:

Manual Part Number: C27406

2.11.17

Issue: 2

CONTENTS

- 1 - Introduction
- 2 - Safety Precautions
- 3 - Technical Information
- 4 - Unpacking and Installation Instructions
- 5 - Electrical Installation
- 6 - Operating Instructions
- 7 - Fault Finding
- 8 - Maintenance and Servicing
- 9 - Wiring Diagram & General Assembly
- 10 - Spare Parts List

1 – Introduction

It is imperative that this manual is read carefully and understood before installing your equipment. For your future reference please keep this manual in a safe place.

Thank you for specifying a product from the Francis Searchlights range. All Francis products are designed to give complete customer satisfaction and are manufactured to the highest engineering standards in order to ensure optimum performance and service life.

The Francis Xenon range combines features proven over many years service in the most hazardous conditions in both marine and land installations.

In order to prolong the life and performance of your product, we recommend that you only specify Francis Searchlights spare parts. This will also ensure that any warranties on your equipment will not be invalidated. Information on spares ordering and parts is provided in this manual.

Should you ever need to contact Francis Searchlights Ltd. regarding your equipment, please quote the Product Serial Number at all times.

2 - Safety Precautions

The following instructions must be adhered to, in order to ensure a safe working environment and the safety of the user.

Note: When unpacking or manoeuvring the searchlight into its fixing position, suitable lifting points must be used in order to prevent damage to the equipment or personal injury.

- Because of the high internal pressure within the lamp, there is a risk of explosion in either a hot or cold state;
- During operation this lamp emits intense UV radiation which is harmful to the eyes and skin. Suitable protection should be worn;
- The high luminance of the arc can cause severe damage to the eye if viewed directly. ALWAYS wear suitable protective goggles when viewing the lamp;
- Always use protective jackets supplied with the lamp;
- Should it be necessary to examine the lamp with the front bezel removed, always use a protective shield and wear goggles to ensure a safe working environment;
- Searchlights get hot. Never touch the unit when lit and always allow 15 to 20 minutes for cooling down after turning the searchlight off;
- Never place anything on or cover the searchlight when in use;
- Ensure the lamp has cooled sufficiently before removal;
- If undue force appears necessary to remove the lamp, the equipment should be inspected by a competent person or contact the manufacturer;
- When disposing of lamps there are several options available:
 - Return the lamp, via the supplier, to the lamp manufacturer in its complete packaging
 - Because of the cold internal pressure of the lamp is approximately 8 bar, the lamp must first be depressurised before disposal. Place the lamp, in its protective jacket, in a plastic bag and drop from a height of 1 to 2 metres onto a hard surface;
- XBO lamps do not contain materials which are harmful to the environment and thus are not subject to special waste disposal regulations;
- Due to the vast range of lamps available it may appear possible that more powerful lamps can be used in the equipment than for which it was designed. Even when the unit will physically accept a higher wattage lamp, this substitution is not recommended and is dangerous. This action will also void any warranties on the equipment.
- Always refer to the lamp manufacturer's technical data when dealing with lamps.

3 - Technical Information

This product has been designed to operate in accordance with the product specification. The FX380RC 1000 watt searchlight has the following features:

- All marine grade materials and fixings;
- Electronic power supply unit;
- Parabolic glass reflector;
- Powder coated & Stove enamel painted;
- 385° horizontal rotation;
- Vertical movement + 30° to -35°;
- Variable speed 1-23°/sec (Pan), 1-8°/sec (Tilt);
- RS485 connectivity & auto home positioning;
- Remote focus facility;
- Internal self-regulating heater.

The searchlight also performs to the following optical data:

- Xenon light source;
- Lamp Wattage - 1000 Watts;
- Supply voltage – 220v-240v or 110v-115v;
- Peak Beam Candlepower – 45,000,000 lux;
- Range – 6,700 metres;
- Divergence - 1.5°;
- Temperature range: -50°C;

In order that the searchlight operates correctly it is imperative that competent personnel are responsible for the installation, operation and servicing of this equipment. Failure to adhere to this advice may cause premature failure or incorrect operation of the searchlight, which may damage the equipment or cause personal injury.

Technical information on the Power Supply Unit and Ignitor are included overleaf. For more detailed information please contact the manufacturer.

PSU ref.: ECG 1000 XE
Ignitor ref. ZG 60 XE

ECG 1000 DC-C

Type HBX1000

Electronic Control Gear for DC short arc lamps up to 1000W

Please read this information carefully, before installing and operating the power supply!



-All rights reserved-

Suiting igniters

ZG 60Xe 60Amps igniter with asymmetric ignition,
for Anode or Cathode Ground operating

ZG 120Xe 120Amps igniter with asymmetric ignition
for Anode or Cathode Ground operating

Features:

-
- Power supply for xenon filled short arc lamps, **DNVGL-CG 0339 certified**
 - Designed for Xenon short arc lamps rated **up to 1000W/ 66A**
 - Output power customer selectable by control Voltage **0-5V**
 - Capable to drive lamp voltage ranges from **15 to 29V**
 - **Ballast boards inside IEC(UL) 60601 certified and HALT tested**
 - Input voltage range **90V AC to 264V AC**, power factor corrected, built-in EMI-filter: meets CE and FCC part "A"
 - μ P controlled, digital power management with high output stability over lamp lifetime
 - Output short circuit protected and "Arc to Ground" protected
 - Operation with Cathode or Anode to Ground/PE possible
 - Galvanic separation of lamp output and line input, thermal shut off at 90°C
 - Shut off function for end of life and lamp fail parameter
 - Ballast cascadable for use for higher wattage Xenon lamps
 - Auxiliary regulated 24V/ 0.2A output for Subsystems, **permanent available**
 - For OSRAM, Ushio, Luxtel, Superior Quartz, Excelitas, PerkinElmer lamps
 - Flexible Design: new lamps and functions adaptable by software

Electrical Data

All values are valid at $25 \pm 5^\circ\text{C}$, unless otherwise noted

Input Data

| Nominal Operation | Symbol | Unit | Nominal | Tolerances | Remarks |
|------------------------------|----------------|---------------|-----------|-----------------------|----------------------|
| Input voltage AC Line | U | V AC | 100-240 | 90 - 264 | |
| System wattage | P_{LI} | W | | 600 -1150 | depends on select |
| Input current | I_{LI} | A | | 5 – 14 | depends on select |
| Line frequency | f_{in} | Hz | 50/60 | 47 – 63 | |
| Line Power factor | PFC | 1 | 1.0 | 0.92 to 1.0 | |
| Line inrush current limiting | A_{peak} | | 13 | Limiting Element will | be shorted by Relais |
| Leakage Current to PE | I_{Leak_SA} | μA | <500@230V | | Standalone |

| Other Operation Data | Symbol | Unit | Nominal | Tolerances | Remarks |
|----------------------------------|--------------|------|---------|------------|---------|
| System wattage during ignition | P_{Iign} | W | 25 | <30 | |
| System wattage standby-operation | P_{LIstby} | W | 1,5 | 0.5 – 2.0 | |

Lamp Output Data

| Ignition | Symbol | Unit | Nominal | Tolerances | Remarks |
|-------------------------------|----------------|--------------------|---------|------------|--------------------|
| Ignition voltage with ZG ..Xe | U_{Iign} | kV _{peak} | 30-35 | | Depends on Igniter |
| Ignition time | | sec. | 1 | 0.9 – 1.1 | |
| Automatic restart counter | t_{Iign_on} | | 5 | | attempts |

| Run-up Operation | Symbol | Unit | Nominal | Tolerances | Remarks |
|--------------------------------------|------------------------|--------|---------|--------------|--|
| Run-up Current @ 15V Lamp-voltage | I_{max} I_{max} | A A | 66 | +10% Max. | Inside specified lamp-parameter (select by internal Mode-switch) |
| In rush Current | I_{max} | A | 80 | | 0 to 1ms |

| Nominal Operation | Symbol | Unit | Nominal | Tolerances | Remarks |
|---|---------------------------------|------|----------|------------|---------------------------------------|
| Lamp voltage | U_{La} | V | 10 - 29 | +/-5% | Depends on lamp select |
| Lamp wattage | P_{La} | W | 1000 | +/-2% | Fixed factory set-up Mode #4 1000W |
| Lamp current | I_{La} | A | Up to 66 | | Depend on set-up |
| End-Of Life-Cut off voltage | $U_{La, max}$ | V | 30 | +/-1V | After run-up completed |
| End-Of-Life-Cut off time | $t_{EOL-Off}$ | S | < 0.2 | | |
| RF-Ripple of output power | $\Delta P_{La,rip} / P_{La}$ | % | < 1 p-p | | 15,5V-30V |
| 50Hz –60Hz Ripple | | % | < 1 p-p | < 4 p-p | 13V 30V |
| Shift in output power with shift in input voltage | $\Delta P_{La} / \Delta U_{LI}$ | 1 | | < 0.005 | within nominal values |
| Open circuit voltage for ignition | U_{ocv} | V | 110 | 105 –120 | |

LIFETIME DATA

All values for $U_u = 230 V_{mrs}$

Temperature at test point = 70°C

| | Symbol | Unit | Nominal | Tolerances | Remarks |
|------------------|------------|------|---------|------------|--|
| ballast lifetime | t_{Life} | h | 25.000 | > 25.000 | acc. To MIL HDBK for nominal operation |

MISCELLANEOUS DATA

| Nominal Operation | Symbol | Unit | Nominal | Tolerances | Remarks |
|---------------------------------------|-------------|------|----------------------|------------|---|
| Power losses at 115V at 230V | P_V | W | 60 – 180 45 - 160 | +/- | Depends on power select |
| Efficiency | η | 1 | 0.85 | 0.8 – 0.9 | Depend on Lamp current |
| Ambient temperature | T_A | °C | + 25 | -10 - +50 | non condensing |
| Internal temp. switch off temperature | T_{c-off} | °C | +90 | +85 - +95 | At heatsink no de-rating till switch off |

| Standby Mode | Symbol | Unit | Nominal | Remarks |
|---|-------------|------|---------|---|
| Minimum mains shut-off time for restart | T_{reset} | s | 3 | Standby mode is present when the lamp doesn't light 1. when ignition hasn't been successful 2. when lamp output is shorted 3. when lamp extinguishes while running |

| Geometry and Weight | Symbol | Unit | Nominal | Tolerances | Remarks |
|----------------------------|--------|------|-------------|------------|-----------|
| Length | l | mm | 170/220/224 | +/-1 | See dwg. |
| Width | w | mm | 132/139 | +/-1 | See dwg. |
| Height | h | mm | 141 | +/-1 | see dwg. |
| Housing | | | | | Closed AL |
| Weight | W_B | g | 2660 | | |

| Wiring length | Symbol | Unit | Nominal | Tolerances | Remarks |
|-----------------------------|----------|------|---------|------------|--------------------------|
| Between igniter and lamp | L_{ll} | mm | | t.b.d. | As short as possible |
| Between ballast and igniter | L_{bl} | mm | t.b.d. | t.b.d. | External Igniter ZG 60Xe |

| Cooling method | Symbol | Unit | Nominal | Remarks |
|-----------------------|---------|------------------|--------------|---|
| | airflow | meter per second | Built in fan | Thermal Situation must be checked in actual application |

| Plugs and Cables | Manufacturer / Type | Remarks / Header/Contacts |
|-----------------------------------|--|---------------------------|
| Ballast mains plug CN 1 | Screwable for wires up 1.5qmm/ for max. input current = 14Amp | See drawing on page 5 |
| Ballast Control interface plug | ST 1 JST / B6B-EH-A I Isolated to line voltage. GND connected to PE | See drawing on page 5 |
| Connection Ballast to Igniter | By Screw M5 and Cable-shoes (Cu16-5) for 16qmm | See drawing on page 5 |

PIN Assignment and Fuse

| Connector | | Signal | Status | Description |
|---|---|--|--------|--|
| Line input CN 1 | PIN 1 PIN 2 PIN 3 | AC in -L- AC in -N- PE | | AC - wide range input Voltage 90V – 264V AC-230V ± 15% with GL certification Safety Ground |
| CN 1 | PIN 4 (-) PIN 5 (+) | ON-OFF/GND By switch, by open collector or by control voltage 0-24V | | Universal ON-OFF control input |
| Lamp output Terminal | Copper rails, tapped with M5 for cable shoes (Cu16-5) | Plus Lamp Voltage Minus and Power | | Connection to external Igniter ZG 60Xe ZG 120Xe |
| Option Board terminal ST1 opto-isolated | Pin 1 Pin 2 Pin 3 Pin 4 Pin 5 Pin 6 | GND/PE/CN1-Pin4 Power control input +5V ON-OFF/CN1-Pin5 Lamp Lit feedback +24V-0, 15A auxiliary out | | GND and 24V return Voltage or PWM control, 5V =1000W, 0V=500W Use for power-control potentiometer ON-OFF input, Power On = <1V Open collector output (NPN), OK is low For external subsystems |
| Fuse | | Fixed built -in 3xT 5A/ 250V | | CAUTION! For Continued Protection Against Risk of Fire, Replace Only with same Type and Rating of Fuse |

| Standards | |
|---|--|
| Safety and performance Certifications | UL 60601-1, IEC 60601-1 (CB) for ballast boards HBX180 CB- Test, and UL must be completed with the final product |
| RFI – (Radio Frequency Interferences) (Funkentstörung) | has to be done with complete assembled project, built-in EMI-filter, that meets CE and FCC (A) requirements, for “B” an additional Filter is recommended (has to be tested with final product) |

| Environmental Requirements | Ambient conditions | Remarks |
|-----------------------------|---|----------------------|
| Storage Temperature Range | -20°C - +60°C | |
| Operating Temperature Range | -10°C – 40°C | Acc. to DNVGL-CG0339 |
| Humidity Range | 20% - 95% non condensing | Acc. to DNVGL-CG0339 |
| Altitude operating | 0 Ft. to 10000 Ft. | |
| Altitude not operating | 0 Ft. to 40000 Ft. | |
| Vibration operating | G _{rms} , 5 Hz to 500 Hz random 10min x y z axis | Acc. to DNVGL-CG0339 |
| Vibration not operating | G _{rms} , 5 Hz to 500 Hz random 10min x y z axis | Acc. to DNVGL-CG0339 |
| Shock operating | G _{rms} , ½ sine wave, 11ms x y z axis | Acc. to DNVGL-CG0339 |
| Shock not operating | G _{rms} , ½ sine wave, 11ms x y z axis | Acc. to DNVGL-CG0339 |

Specifications subject to change without notice

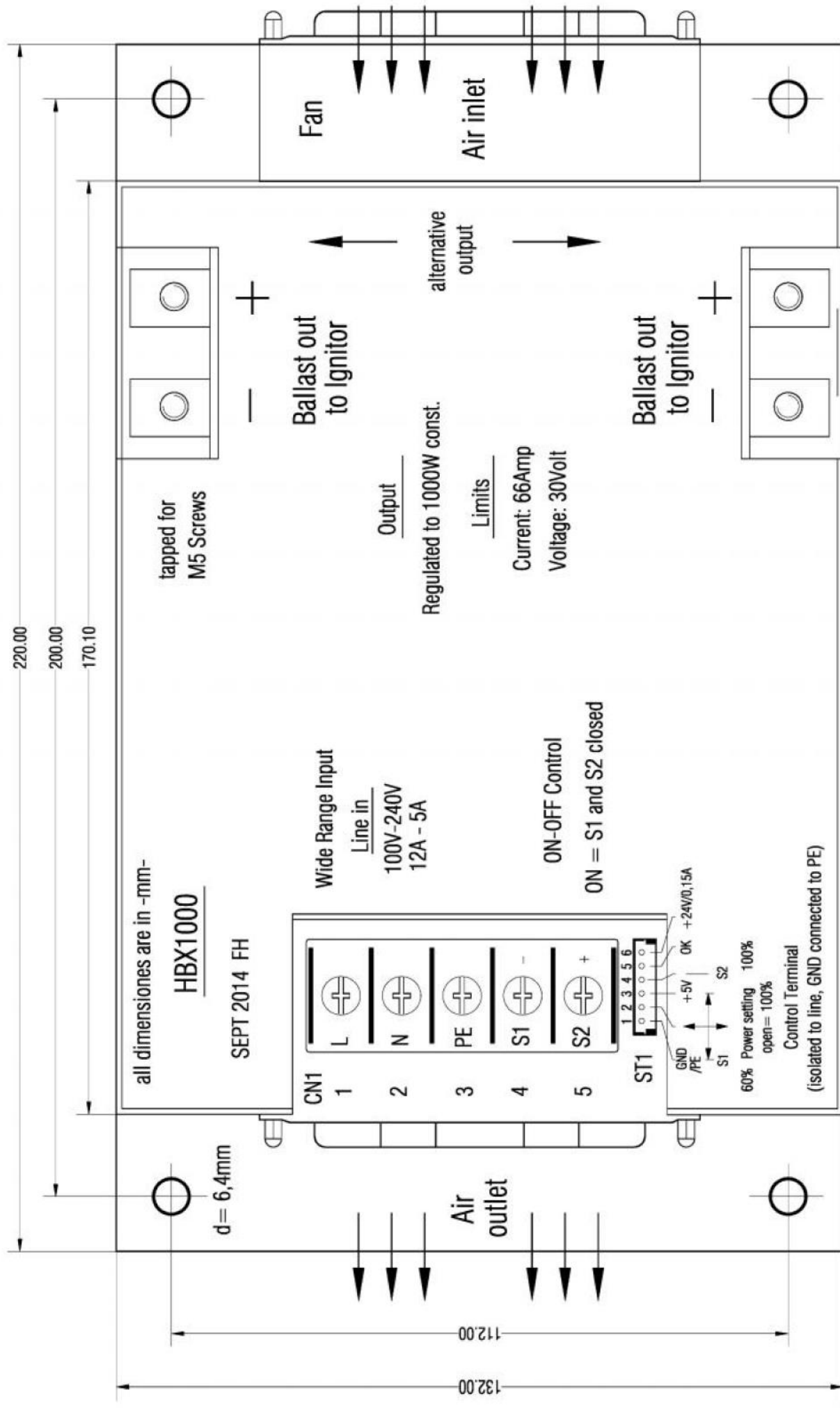

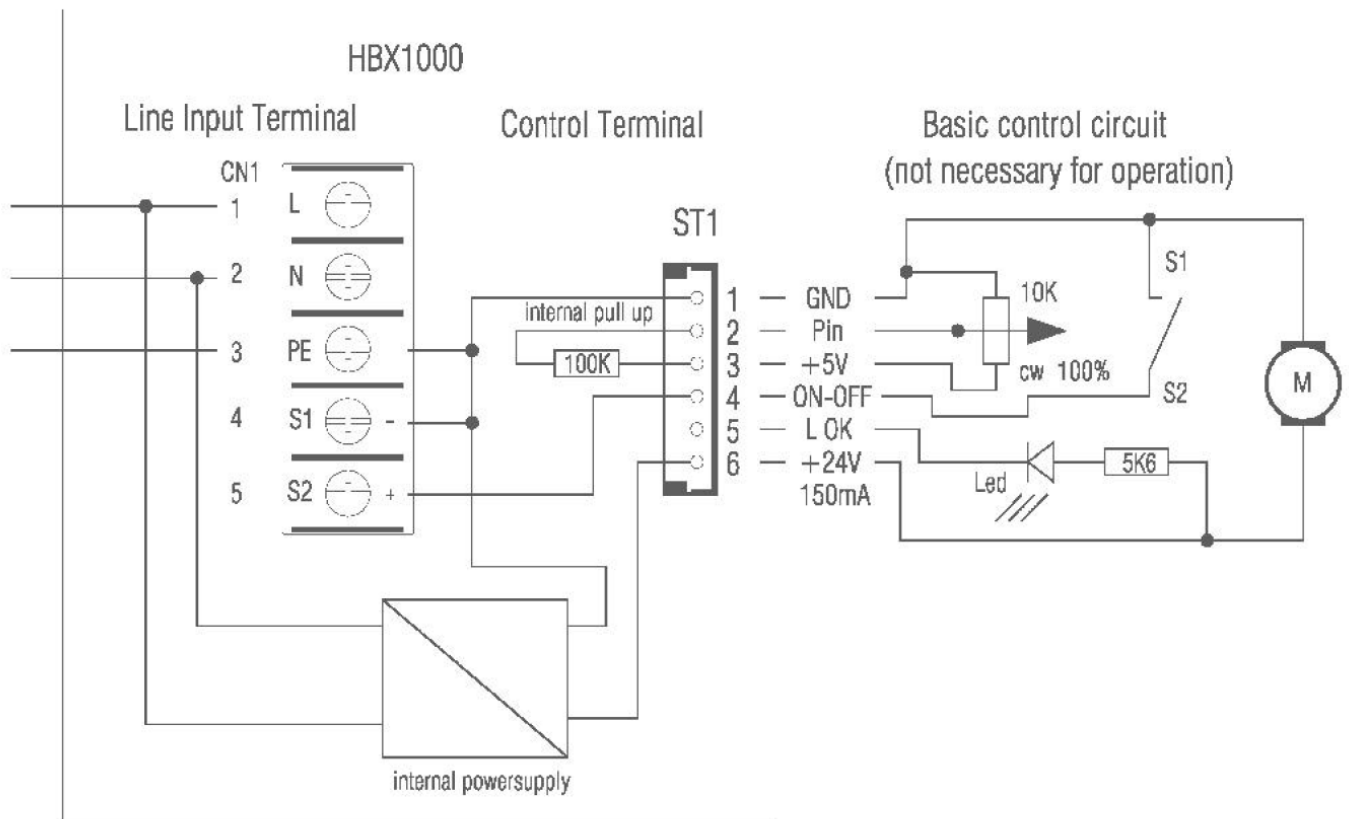

Basic circuit for use:

Pin 4 for ON-OFF is a multiple use universal input, which can be driven by signals up to 24V. To operate the lamp S1 and S2 must be closed.

Pin 3 is a high impedance input for Power adjust. It can be driven by voltage between 0V and 5V or by 5V PWM Signals with 100Hz to 500Hz. It can remain open for 100% output Power.

Pin 5 is an open collector Output to drive a Led for amp OK operation.

Igniter connection



Additional hints for use and safety:

1. Safety

Because of instant hot restrike, the output voltage to the lamp can reach values of up to +/-15000 Volts! Please ensure minimum 15mm clearance between all lamp terminals to PE, to prevent arc to ground situation!! Primary wiring has to meet national requirements for electrical safety!

2. Lamp power selection:

By multimode 16-step switch (0-F). **Only factory setup. Not for end user.**

3. Auxiliary 24V Output

The unit has one 24V output terminal for driving subsystems.

The maximum output current for this output is total 150mA.

The 24V output voltage is permanently available, even when the lamp is not in operation!

This terminal is connected to PE with GND (24V return)!

4. Cooling

This unit is assembled with an internal fan, which ensures proper operation at ambient temperatures up to 50°C. Nevertheless it is necessary to keep air in- and outlet free.

Temperature overload is protected by an internal temperature switch at 90°C at the internal heatsink.

5. Fuse and Safety

CAUTION! For Continued Protection Against Risk of Fire, Replace Only with same Type and Rating of Fuse! The fuse is a fixed built-in component with T5A / 250V rating.

If one of the fuses has failed, the power-supply must be returned to the factory for repair.

6. Increasing reliability and functions

Custom modifications of power curves and adaption to other lamp types are possible upon request.



Front View



Back View

General

This unit is developed to drive Xenon short arc Lamps for Search- and Head-Lights used in general marine applications and other too.

Safety Installation

These units are developed to be installed under protection class IP0x , where power output and line input terminals are not protected to be touched by hand. This means that the installation should be inside an electrical cabinet, which ensures the certified ambient test conditions like heat and moisture a.s.o. and protects the terminals to be touched by hands and fingers and tools!

The cabinet has to be signed by a label which clearly announces to switch off the line voltage before opening!

EMC

To ensure the certified DNV-GL EMC requirements, it is necessary to use an external EMC- Filter for the line input. The filter type is: **EMV 575-5**.

Other filter types can be used too, but they need to be certified by DNV-GL. DNV-GL certification is only valid for operation with 230V line voltage.

Cables for Line Input wiring

Protection Class1: Type LIY 0,75 mm² acc. VDE 0882 (L sw, N bl, PE gegn) (black, blue, yellowgreen)

Terminals: Type Screws at ballast side, 6.3x 0.8mm Amp faston and cables shoes with 3mm dia hole for filter side.

Cables for Ouput wiring to Ignitor

Output Current at HBX500 max 44A Cable = LIY 6mm² /600V

Output Current at HBX1000 max 66A Cable =LIY 10mm²/ 600V

Cable shoes for terminals: for Screws M5 at ballast side and M6 at ignitor side

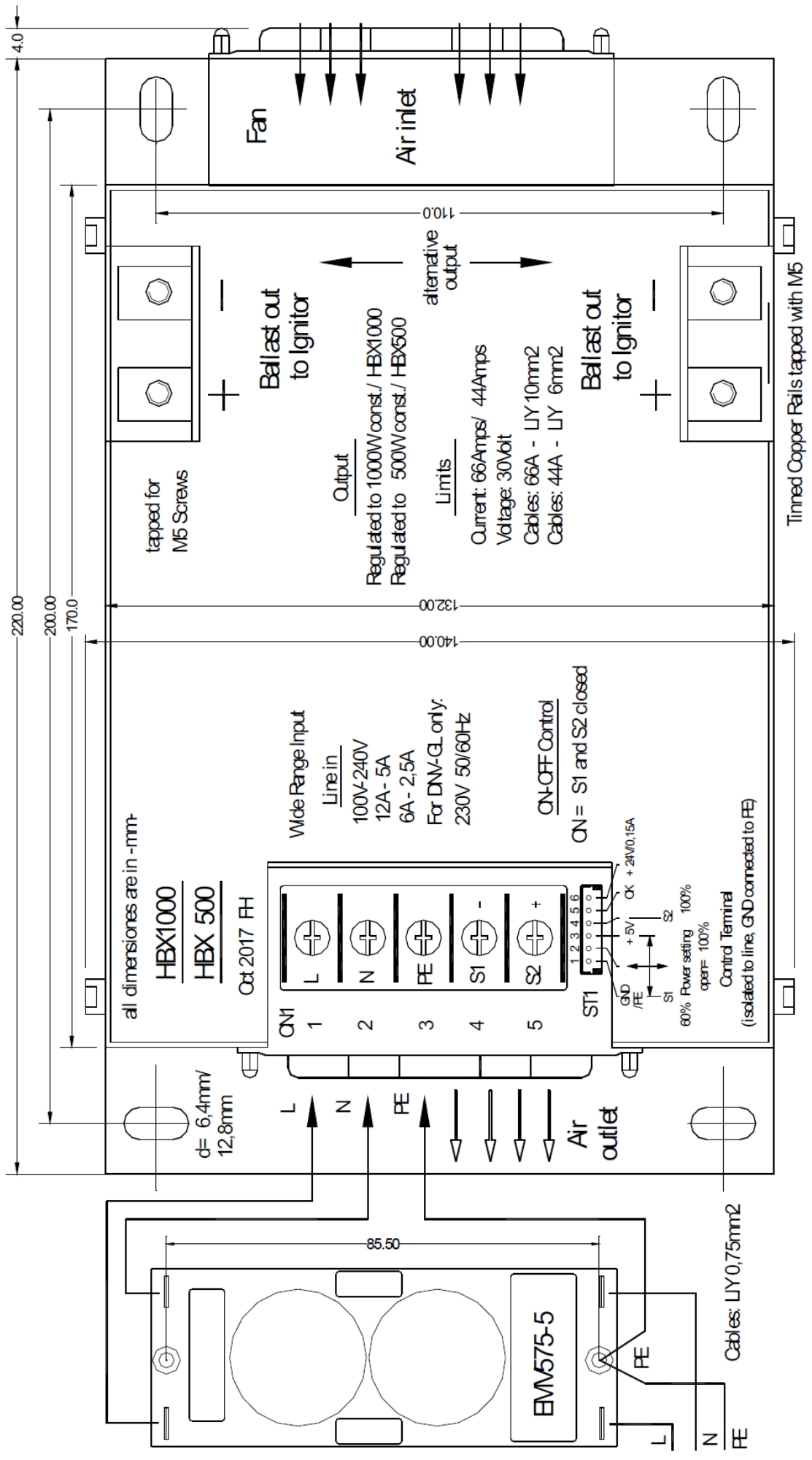

HBX500- HBX1000 Output Power 500W - 1000W vrs. U Lamp

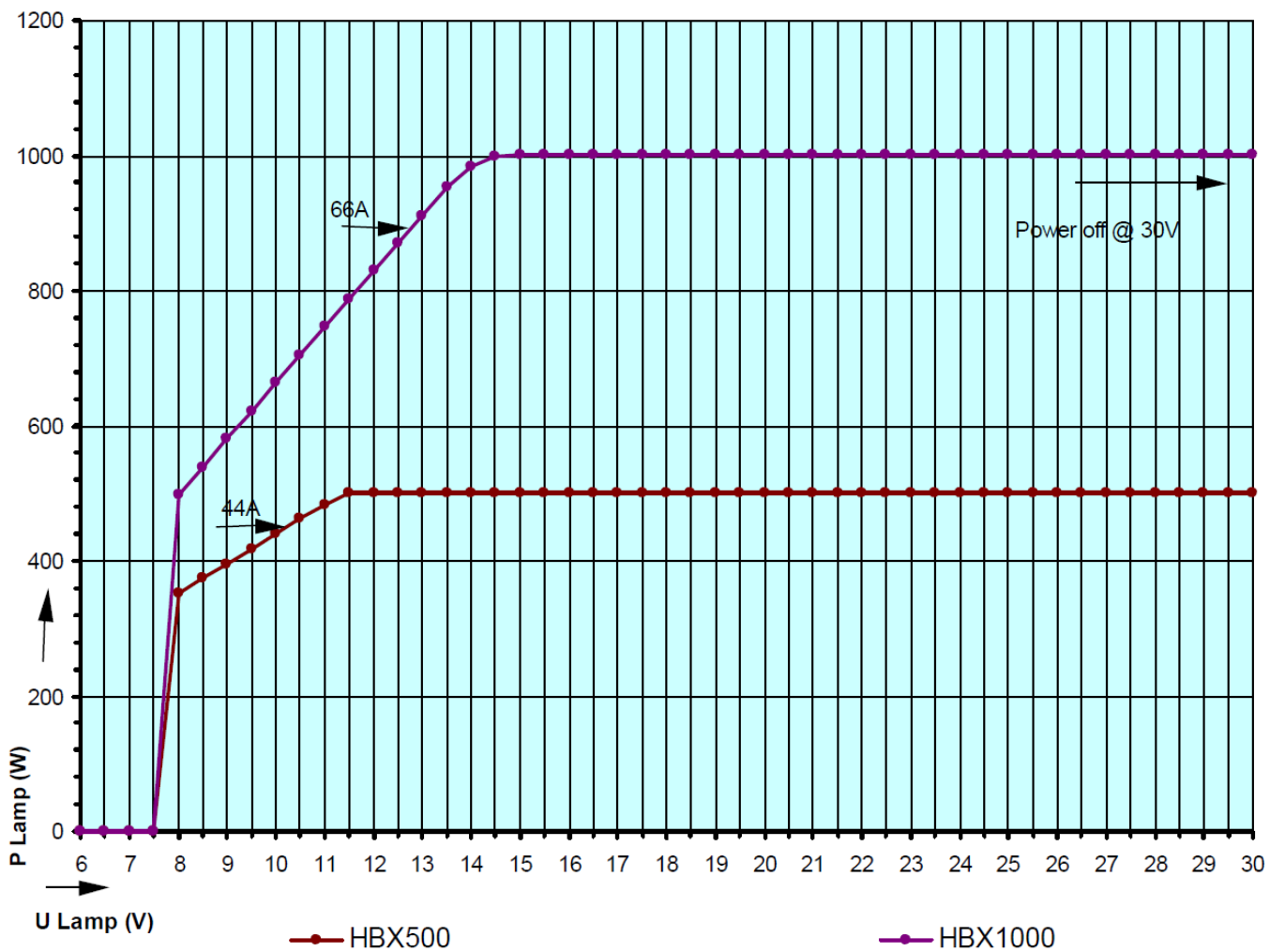



DATA SHEET

ZG 60 XE

Igniter for low voltage DC-Lamps with Lamp-Current up to 60 A

Features

Revolutionary drive system: needs no external power source, self synchronisation with ballast

- Igniter for DC-Xenon and Hg discharge lamps operated by electronic ballasts
- Suitable for low voltage and high current DC lamps with lamp voltages up to 100 V DC
- Nominal current of up to 60 A with natural convection
- Maximal current of 80 A with additional airflow
- Compliant to RoHS-directive 2002/95/EC
- Self stopping operation (2sec)
- DC-Impedance of about 1700 $\mu\Omega$
- DC-Powerloss of about 6,2 W @ 60 Amps, 10,8 W @ 80 Amps

ZG 60XE

TECHNICAL DATA

| | |
|---|--|
| Rated current | 60A, no add cooling |
| Temporary over current < 3 min. within a period of 6 min. | 100 A |
| Ignition voltage | Higher than 32 kVp (40 KV nominal) |
| Input voltage range | DC 0-160 V / threshold for Ignition > 70 V |
| Operation mode | Asymmetrical: cathode or anode grounding |
| Ignition mode control | Self stopping Igniter nearly 2 sec./self sourcing by ballast, no external source necessary |
| Pulse rate | Approximately 30/sec. @ 70 V |
| Repetition rate | Depend on ballast, break of min.10 sec. is required |
| Operating temperature | 115°C max. @ Ignitioncoil TP 1 / 85°C @ TP 2 |
| Cable length | HV to lamp 50 cm max., for hot re-ignition: short as possible |
| Dimensions (L x W x H) | 115 x 103 x 30/45 mm |
| Weight | Roughly 720 g |
| Connectors | 4 x M6 screw-terminals with nuts M6 for cable-shoes |

REGULATORY SPECIFICATIONS

| | |
|--------|-------------------------------|
| Safety | According to IEC (UL) 60950-1 |
| RoHS | According to 2002/95/EC |

4 - Unpacking and Installation Instructions

The following instructions should be read and fully understood prior to installing the equipment to ensure that the correct procedures are followed, and all safety precautions are observed.

Note: If the equipment has been in storage for a considerable amount of time, it is advisable to conduct a routine maintenance check on all parts before installation.

Safety Precautions

This equipment should not be connected to an electrical supply before being installed. Installation procedures should be adhered to in order to ensure a safe working environment and reduce the risk of damage or personal injury.

Preparing the Mounting Position

Mark out and drill the fixing holes through the deck (refer to drawing C21501). If anti-vibration mounts are to be fitted, the fixing holes for the mounts should also be marked out and drilled. Prior to manoeuvring the searchlight into its' fixing position, the AV mounts should be fitted to the base. When in the desired position, bolt the searchlight firmly down. On an uneven surface it may be necessary to use a suitable sealant such as silicone, in order to ensure a weatherproofed joint.

5 - Electrical Installation

Note: ~

When the main power is first applied to the searchlight, the searchlight will carry out a self-test, it will Pan to the left limit and Tilt down to the limit, once this is complete, the searchlight will then move to the centre and horizontal, during this please do not try and operate the searchlight while this test is being carried out. Once the searchlight is back at centre the searchlight can then be operated normally, by pressing the Panel button on the control panel.

For safety purposes, only competent personnel should perform the electrical installation. All equipment should be installed to current Electrical Regulations and Standards.

In order to obtain the maximum light output from the searchlight, it is essential that the full operating voltage of the lamp fitted be applied to the lampholder contacts.

Method of Electrical Connection

- 1) Disconnect the supply before working on the electrical system;
- 2) The searchlight must be connected to a fused electrical supply, using suitably sized cable;
- 3) If the searchlight is located a considerable distance from the mains supply, provision must be made in the cable size in order to overcome the voltage drop.

The PSU should NOT be positioned no more than 5 meters away from the Searchlight.

The following table below indicates the maximum length of cable to be used for the AC supply cable, from the junction box to the searchlight:

| Searchlight | 115v 1Kw | 240v 1Kw |
|-------------------------------|--------------|--------------|
| Cable Size (mm ²) | Distance Max | Distance Max |
| 1.5 | 17 MTRS | 75 MTRS |
| 2.5 | 28 MTRS | 123 MTRS |
| 4 | 44 MTRS | 195 MTRS |
| 6 | 68 MTRS | 304 MTRS |
| 10 | 115 MTRS | 509 MTRS |

- 4) Whenever possible cable terminations should be made below deck and with approved terminal devices;
- 5) If a spare auxiliary fuse or circuit breaker is not available, one of the correct type and rating should be fitted and connected to a positive supply. It is advisable to locate a bus bar or main connection and avoid any direct connection to the supply;
- 6) For 110/220v AC products, the following colour coding system should be used for the customer supply cable:

Brown - Live
Blue - Negative
Green/Yellow - Earth

Note: This equipment must be earthed.

Installation Guidelines

A typical installation and connection routine for the FX380RC searchlight is as follows:

Referring to wiring diagram C27405 a supply is fed to the junction box, which then provides a common feed to the motor gearbox, searchlight, power supply unit and joystick panel.

The searchlight has been pre-wired with 3 meters of cable from the motor gearbox to junction box provided. The searchlight head is pre-wired along with the connecting cable to the motor gearbox.

Cables required to be connected by the customer: -

2 pair twisted 0.22mm 100 ohm screened cable from the joystick panel to the junction box.

5 cores 1.5mm cable from the PSU to the junction box.

4 cores 4mm cable from the PSU to the junction box.

Supply cable to the junction box.

Basic Operation

When the searchlight is switched on a supply is fed to the PSU and linked to the ignitor. Also, from the PSU, a dc output is fed to the lamp.

The ignitor ionises the gas within the lamp and this strikes the light.

All other facilities are fed via the control panels and motor gearbox.

When the light is in operation, the output from the PSU should be approximately 19v dc and 50 amps.

Upon striking, the running wattage of the lamp can be calculated by using the equation:

$$P = VI$$

Where P= Power (watts)

V= Voltage (V)

I = Current (Amps)

Instruments required: D.C. Ammeter & Multi meter

Procedure

- 1) With the multi meter, test the DC voltage in the searchlight head. This should be approximately 19 volts.
- 2) With the D.C ammeter, test the current of the red DC cable at front of searchlight. It should read approximately 50 amps.
- 3) Multiply these readings together, as shown above, to obtain the desired wattage required, usually about 950watts.

Fitting instructions for the 1Kw xenon lamp

Referring to the diagram overleaf:

- 1)** Unfasten eight latches (A) on the front and rear of the searchlight;
- 2)** Remove the front bezel (B) and rear bezel (C) assemblies;
- 3)** Unscrew the two M6 hexagon screws (D) from the front lampholder mounting block (E) and remove the front lampholder assembly from the mounting bracket;
- 4)** Loosen the knurled screw on the front (F) and rear (G) lampholder assemblies;
- 5)** The lamp can now be inserted, make sure that the negative (cathode) end of the lamp is towards the rear of the searchlight & the cathode (negative) adaptor is securely fastened to end of lamp;
- 6)** Tighten the knurled screw (G) on the rear lampholder assembly to hold the lamp in position;
- 7)** Fasten the front lampholder mounting block back in position, it will be necessary to pull the front socket against its spring to fit over the lamp. When in place tighten the front knurled screw (F);
- 8)** Fasten the front and rear lampholder leads as wiring diagram, ensuring the connections are secure;
- 9)** The front bezel and rear bezel can now be replaced;
- 10)** Removal is the reverse of the above. When replacing the lamp retain cathode (Negative) adaptor C13544-37 for re-use. (See instruction 5 above)

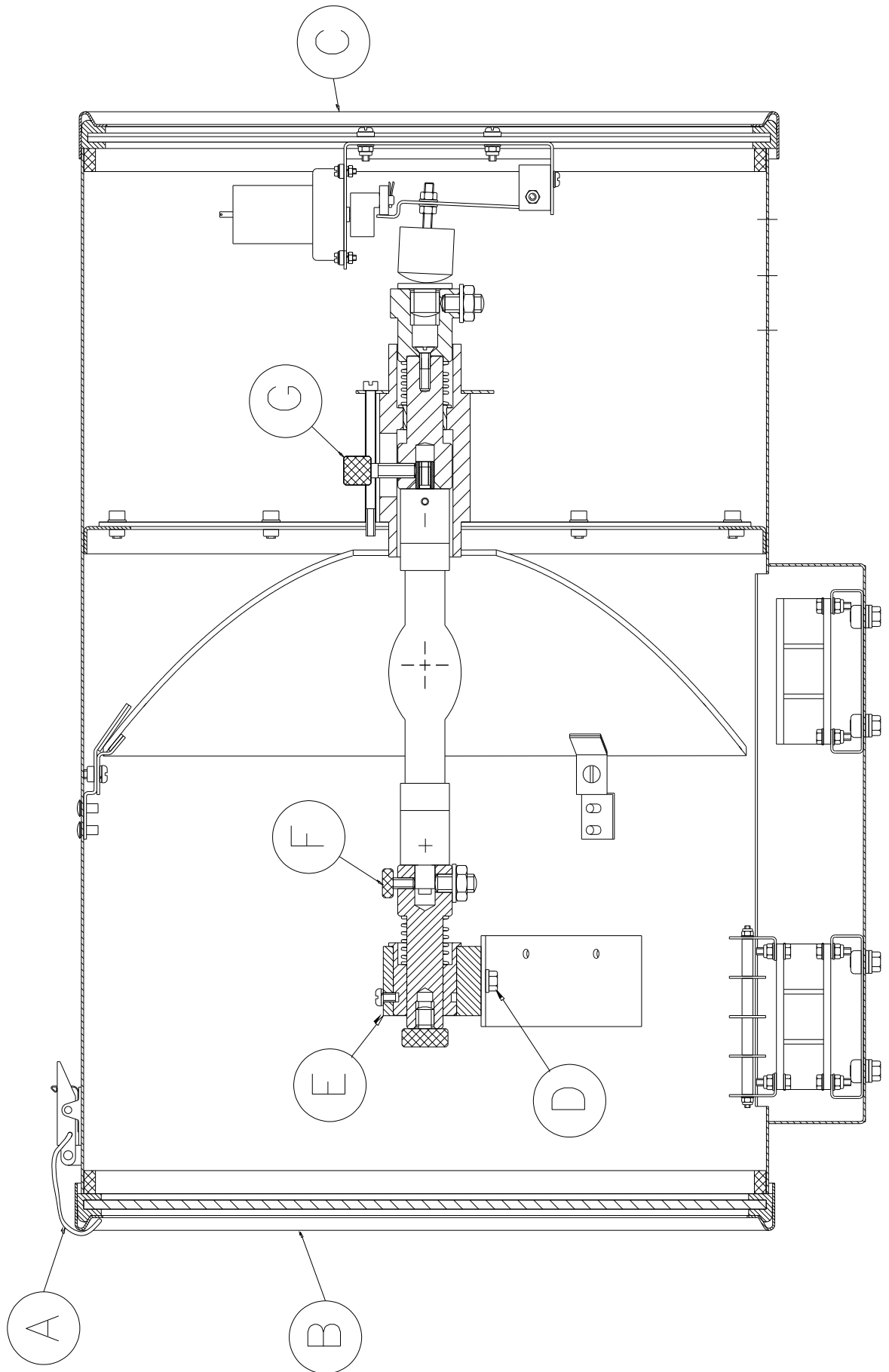

6 - Operating Instructions

This equipment is designed for use out of doors, in free air. Never place anything on or cover the searchlight when in use as this may present a hazard.

The searchlight can be remotely positioned via the joystick control panel, with the facility for movement up, down, left and right. (See Fig 1 below for aid to instructions)

To operate the panel, press panel button (1), the button will light up & the joystick (4) is now operational. To switch the lamp on or off press the lamp button (2)

The speed of movement depends on the more pressure applied to the joystick (4) the faster the searchlight moves. When in the desired position the joystick should be released so that it returns to dead centre.

On remote focus models the beam of the searchlight can be adjusted to give a variety of beam types. Using the focus button (3) on the joystick panel, the desired beam can be achieved for any particular application. The beam will move continuously through 'spot' to 'flood'. In order to fix the beam type, simply release the focus button at the desired position.

To return the searchlight to Factory set auto home position (forward and horizontal) simply switch off the joystick panel using the panel button (1) and then press the lamp button (2), the searchlight will then move to the pre-programmed home position.

To set a new Home position, move the searchlight to the desired home position, switch off the panel (1), move the joystick to the downward position ↓ and simultaneously press the Lamp button (2).

There is the option for added slave panels, the slave panel has all the features of the main control panel i.e. joystick, focus and on/off.

When the lamp is switched on, this will illuminate the Lamp button (1) on both the Main & Slave Control panel, also when the Focus button (3) is pressed, both Focus buttons will be illuminated.

The brightness of the panel can be increased or decreased by holding the panel switch (1) down and moving the joystick left and right, left to decrease right to increase.

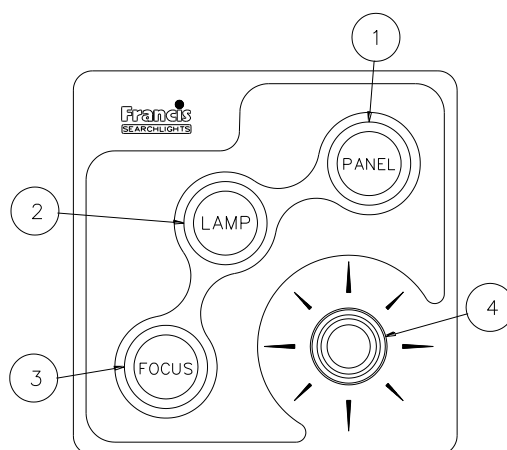

Fig 1

Setting to Work

Safe service in use necessitates the strict observance of the following precautions.

- * Any article fabricated from quartz or glass is inherently fragile and care should therefore be taken, at all times, when handling lamps;
- * Eye protection must be worn when handling lamps that have been removed from their packaging materials. The protective jacket should not be removed from the lamp for safety reasons, as there is a remote possibility of the lamp shattering violently, especially if it is subjected to mechanical shock or vibration;
- * Ensure that the power rating of the Xenon lamp to be fitted is suitable for the lamp house and power supply equipment (rectifier);
- * Always isolate the equipment from the supply before inserting a lamp;
- * Before inserting the lamp ensure that all contacts are clean. Contacts must be renewed at the slightest sign of corrosion. Sanding or filing down corroded areas is not recommended as this will only make the conducting surface between the pin and lampholder smaller, thus causing the lamp to overheat;
- * The inert gas (Xenon) used in XBO lamps are under a pressure of several bar even when the bulb is cold. **FOR SAFETY REASONS THE LAMP MAY ONLY BE INSERTED INTO THE LAMPHOUSE WITH THE PROTECTIVE JACKET FITTED;**
- * Do not twist or bend the fused quartz bulb when fitting the lamp as mechanical stresses **MUST** be avoided;
- * Ensure that the spring contacts firmly surround the pins on the cap of the lamp. Do not apply unnecessary force when tightening the screws;
- * After inserting the lamp, ensure that there is sufficient axial play in the lampholder. The lamp must be capable of unimpeded expansion when it warms up to operating temperature. Mechanical forces must not be applied to the fused quartz bulb;
- * Electrical leads must be arranged in such a way that there is a sufficient air gap (approximately 40mm) between them and the lamp house, in order to prevent flashovers from the ignition voltage. All flexible leads must have strain-relieving clamps;
- * Before putting the lamp into service for the first time, check the polarity of the electrical connections. **INCORRECT POLARITY WILL CAUSE IMMEDIATE DESTRUCTION OF THE LAMP;**
- * Before the protective jacket is removed, suitable protection must be worn i.e. face mask and gloves with wrist protection;
- * Never touch the quartz bulb with bare hands, as fingerprints will make the glass cloudy and cause a severe loss of light. This may also cause re-crystallisation and thus weaken the bulb material. Should the bulb be inadvertently touched, remove fingerprints with methylated spirit and a clean, soft paper towel. The bulb should then be wiped with distilled water. (NOTE: **ALWAYS WEAR MASK AND GLOVES DURING CLEANING;**)
- * All packaging and the protective jacket must be retained for re-use. Whenever removing a lamp, the protective jacket must always be used for safety reasons;

Notes:

- 1) XBO lamps are designed for dc operation only. The dc current may only be varied within the limits of the current control range. A XBO lamp operates best at rated current; over the life of the lamp, the current may be increased to its maximum value to compensate for loss of light. The output of the lamp can be reduced by operating the lamp at minimum current, but this does not prolong the life of the lamp;
- 2) For safety reasons, XBO lamps should be replaced once they reach the end of their average lamp life, and not later than 1.25 times they're average lamp life. After this time there is an increased risk of the lamp exploding;
- 3) The anode (positive cap marked '+') must be on top when the lamp is inserted in the vertical position. If the anode is incorrectly inserted the arc will be unstable, the bulb will blacken more quickly, and the lamp will prematurely fail;
- 4) The HT lead from the high voltage terminal of the Ignitor, must be connected to the cathode (negative cap marked '-'). If the lamp is connected with the wrong polarity it will be irreparably damaged after a very short time.
- 5) In all circumstances the lamp manufacturer's data should be referred to when dealing with lamps.

FBUS SPEED CONTROL ASSEMBLY DETAILS

MAINS CONNECTORS

L Live.
N Neutral
E Earth

TILT CONNECTOR

MR Tilt Motor Red Wire (+)
MB Tilt Motor Black Wire (-)
ER Tilt Encoder Red Wire (5V). (Voyager Brown Wire)
EG Tilt Encoder Green Wire (Phase A Output) (Voyager Yellow Wire)
EW Tilt Encoder White Wire (Phase B Output)
0V Tilt Encoder Black Wire (Voyager Blue Wire)
Tilt Limit Switch Common Black Wire
UL Tilt up Limit Switch Orange Wire
DL Tilt down Limit Switch Blue Wire

PAN CONNECTOR

MR Pan Motor Red Wire (+)
MB Pan Motor Black Wire (-)
ER Pan Encoder Red Wire (5V)
EG Pan Encoder Green Wire (Phase A Output)
EW Pan Encoder White Wire (Phase B Output)
0V Pan Encoder Black & Pan Limit Switch Common
CL Pan Clockwise Limit Switch Orange Wire (As viewed looking down on lamp)
AL Pan Anticlockwise Limit Switch (As viewed looking down on lamp)

HEAD CONNECTOR

0 0V Common for Heater & Focus (If Searchlight has an igniter terminal is not used)
H Heater Active High Output
F Focus Motor Active High Output
S Focus position potentiometer.

FBUS CONNECTOR

0 0V out to Joystick Panels
T Line Terminate (Connect to + for terminate)
+ FBUS Data +
- FBUS DATA -
24 24V Supply out to joystick panels

24 VOLT INPUT

- Negative
+ Positive

LAMP RELAY

Relay input
Relay output

FBUS Speed Control Board

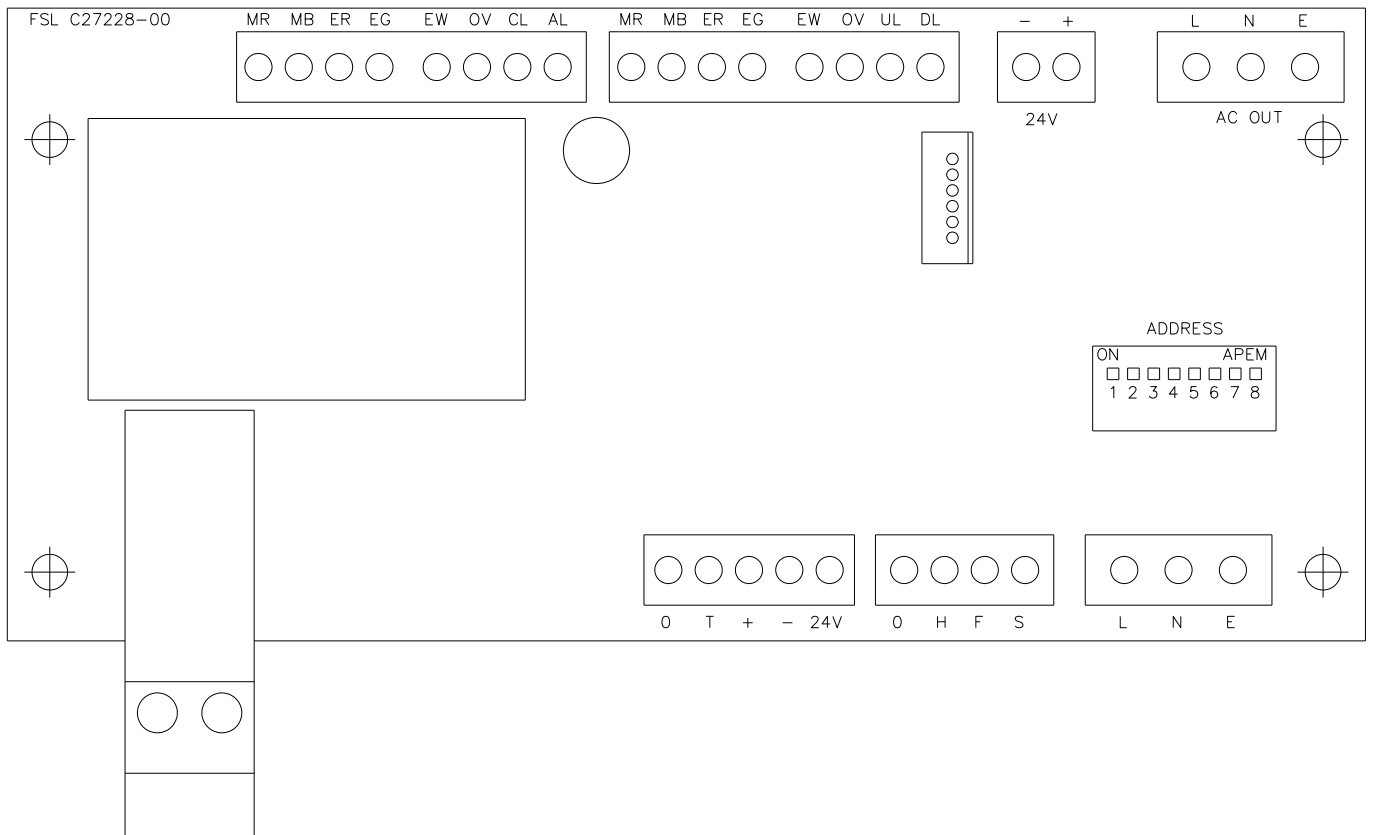

CONNECTIONS TO FBUS JOYSTICK CONTROL PANEL

FBUS CONNECTOR

- 0 OV Supply Input
- T Line Terminate (Connect to + for terminate)
- + FBUS + RS485 Data In/Out
- FBUS - RS485 Data In/Out
- 24 +24V Supply Input

JOYSTICK CONNECTOR

- BK Joystick Black Wire
- Y Joystick Yellow Wire
- BL Joystick Blue Wire
- R Joystick Red Wire

FBUS JOYSTICK CONTROL BOARD

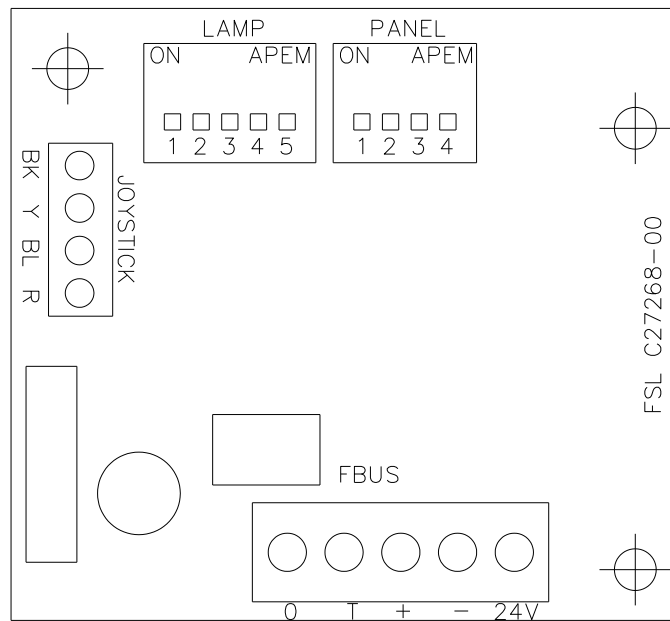

FBUS ADDRESS SWITCHES

OVERVIEW

FBUS uses two types of address switch. One type is rotary, and the value selected is the value shown on the dial. The other type is rows of switches whose operation is described below: -

The switches all operate in the same manner producing a binary value with the highest binary value to the left and the lowest value to the right. The values for each switch are listed below: -

SPEED CONTROL CARD LAMP ADDRESS

| SWITCH NUMBER | VALUE |
|---------------|-------|
| SWITCH 4 | 16 |
| SWITCH 5 | 8 |
| SWITCH 6 | 4 |
| SWITCH 7 | 2 |
| SWITCH 8 | 1 |

STANDARD CONTROL PANEL – LAMP ADDRESS

| SWITCH NUMBER | VALUE |
|---------------|-------|
| SWITCH 1 | 16 |
| SWITCH 2 | 8 |
| SWITCH 3 | 4 |
| SWITCH 4 | 2 |
| SWITCH 5 | 1 |

STANDARD CONTROL PANEL – PANEL ADDRESS

| SWITCH NUMBER | VALUE |
|---------------|-------|
| SWITCH 1 | 8 |
| SWITCH 2 | 4 |
| SWITCH 3 | 2 |
| SWITCH 4 | 1 |

Switching a switch to on, adds the binary value relating to that switch to the address value. With all switches off the value is zero.

EXAMPLES

Standard control panel – panel address set to 5

Switch 1 = Off

Switch 2 = On (Value 4 added to address)

Switch 3 = Off

Switch 4 = On (Value 1 added to address)

$4 + 1 = 5$

Speed control card - lamp address set to 11

Switch 4 = Off

Switch 5 = On (Value 8 added to address)

Switch 6 = Off

Switch 7 = On (Value 2 added to address)

Switch 8 = On (Value 1 added to address)

$8 + 2 + 1 = 11$

ADDRESSING SYSTEM

The addressing system is very simple. Every lamp must have a unique address. The addresses should be sequential and should start from zero. If there were three lamps in a system the addresses should be set to 0, 1 and 2.

Control panel – panel addresses use the same system being sequential and start from zero.

It is essential that all lamp have a unique address with no duplication.

It is essential that all panels have a unique address with no duplication however note that lamps and panels can be the same address. For example, on a system with two panels and two lamps, the panel addresses will be 0 and 1 and the lamps addresses will be 0 and 1.

Control panel lamp addresses are defined by the system configuration. If two panels are used to control the same lamp they must still have individual panel addresses but the lamp addresses can be set to the same address value as the lamp which is to be controlled. Any number of panels can control the same lamp.

FBUS DATA PROTOCOL

OVERVIEW

The Francis bus (FBUS) is a custom communication protocol based on RS485 two wire bi directional communication hardware. The system provides a simple bi-directional link between lamps and lamp control panels. The system allows given panels to communicate with different lamps and also allows a number of panels to communicate with the same lamp.

DETAILED DESCRIPTION

The FBUS system runs at 38.4K Baud. This low data rate facilitates longer cable runs and complements the fairly small amount of data transfer required whilst still providing a fast response. The data frame is 11 bits with 9 data bits, one start and one stop bit. A simple error detection system is employed which is described in detail later. Data is sent LSB first.

To prevent data collisions the system uses a polling technique. Lamp number 0 is the default bus master and controls timing of all communications by polling other units connected to the bus. If lamp 0 is not operating or powered down, lamp 1 automatically becomes the bus master as will lamp 2 if lamp 1 is not operating.

The system differentiates between address and data values by setting data bit 8 high for an address. Panel 2 address would therefore be sent as hex 102 or binary 100000010. The lamps and panels use different address ranges with panels being addresses 0-15 and lamp addresses starting at 16 and going up to 56. A lamp whose address was set to 0 on the address switches will actually be address 16 and would be transmitted as hex 110 or binary 100010000.

If lamp 0 is active this becomes the bus master and sequentially transmits the full address range. No other units will transmit until they receive their address. Each address is followed by a 1mS dead period where the master switches from transmit to receive and monitors the bus for activity. If activity is present the master will not transmit the next address until 1mS after bus activity ceases. After the full panel address range has been sent (addresses 0-15) the master starts to send lamp addresses.

These operate slightly differently in that, if more than three successive addresses do not illicit a response, the bus master will assume the last lamp has been polled and re starts the data cycle by reverting to panel address 0. When a remote panel receives its address, it will send data if it has any to send, if not, no data will be sent. Lamps operate differently in that they will always send data after they have seen their address on the bus. Panels can send data to any lamp therefore they transmit a modified lamp address value prior to the lamp command(s). The modified address is received by lamps and, if it matches their own address, the command(s) which follow will be received and processed.

A detailed description of panel and lamp data follows.

PANEL TRANSMITTED DATA

Panels only send data when there is data to be sent i.e. there has been activity at the panel which must be sent to a given lamp. If there is no data to be sent, a panel will not transmit. The amount of data a panel sends will depend upon the amount of activity at the panel and can be 2 to 10 bytes. The commands described below are sent after a panel receives its address which it uses as indication that it has a transmit time slot. Before any commands are sent the panel must define which lamp the data pertains to. This is achieved by preceding the command with a lamp address. Note that bit 7 is not set when a panel defines the lamp to which it is to transmit. Lamps recognise the address and receive data when the address matches their own. To send commands to lamp number 2 a panel would precede the lamp command(s) with the address value Hex 2, Binary 00000010. It is important to note that multiple commands must be sent in numerical order i.e. a command with value 01 must be sent before a command with 06 etc.

Panel transmit commands are listed below; -

DATA_PAN_JOYSTICK (Hex 01)

This is a two-byte command and must be immediately followed by another byte whose value determines the lamps direction and speed. The value is centred on 128 and has a range of 128 +/- 64. A value of 130 will make the lamp rotate slowly clockwise. Increasing the value will make the lamp move faster. A value of 126 will make the lamp rotate slowly anticlockwise. Decreasing the value will make the lamp move faster. Transmitting values 01 then C0 would make the lamp pan clockwise at full speed.

DATA_TILT_JOYSTICK (Hex 02)

This is a two-byte command and must be immediately followed by another byte whose value determines the lamps direction and speed. The value is centred on 128 and has a range of 128 +/- 64. A value of 130 will make the lamp point upwards slowly. Increasing the value will make the lamp move faster. A value of 126 will make the lamp move down slowly. Decreasing the value will make the lamp move faster. Sending values 02 then C0 would make the lamp tilt up at full speed.

DATA_LAMP_BUTTON (Hex 0A)

This is a single byte command. The same command is sent to switch the lamp on or off. This command must only be sent once for each press of the button. Sending again will switch the lamp again. Basically, if the lamp was off, sending this value will switch it on. If the lamp was on, sending this value will switch it off. This technique is employed to facilitate simultaneous lamp control from a number of different panels. Basically, what is sent is just information that the lamp on off button has been pressed. How the lamp reacts to this depends on the lamps current status. Most of the other lamp button commands operate in a similar manner except the focus button. Confirmation that the command has been received can be obtained by reading the lamp status byte described below.

DATA_FOCUS_BUTTON (Hex 0B)

This is a single byte command. When the lamp receives this, it will run the focus motor as long as the command remains. A panel will send this command so long as the focus button is pressed.

DATA_HOME_BUTTON (Hex 0C)

This is a single byte command. A lamp receiving this will automatically move to the pre-set home position. The command does not need to be maintained while the lamp moves to home.

DATA_RECORD_BUTTON (Hex 0D)

This is a single byte command. The first time a lamp receives this command it will enter record mode and start monitoring all movement and lamp switching information. Recording will continue until the command is received again when it will stop recording. As with most of the button commands it is essential this command is just sent once. Confirmation that the command has been received can be obtained by reading the lamp status byte described below.

DATA_PLAY_BUTTON (Hex 0E)

This is a single byte command. The first time this is received a lamp will start playing back any movement / lamp switching activities which were recorded using the record function above. This will continue until the command is received again or the lamp receives a move command (DATA_PAN_JOYSTICK or DATA_TILT_JOYSTICK).

DATA_HOME_LP (Hex 0F)

This is a single byte command which activates when the home button is pressed and held for 5 seconds (Home Long Press). This is used to store a new home position. A lamp receiving this command will store the current position as the value to move to when the home button is pressed normally. Note that a lamp can only receive up to 10 bytes at a time. A panel's transmit sequence is the modified receiving lamp address followed by data commands then the CRC. The CRC is formed by the sum of all the commands + the lamp address value – note however that the address value used in the CRC is the unmodified value (Bit 7 clear).

DATA_PAN_POSITION (Hex 18)

This is a three-byte command. Following the DATA_PAN_POSITION command two data bytes specify the position to which the lamp must move. The bearing resolution is 0.1 degrees. The value is sent LSB first with the first byte representing the lower position command bits. The MSB (sent last) lower 4 bits represents the remaining value. The position value is centred on 2048 (Binary 1000 0000 0000) so a value of 2048 would make the lamp move to the dead ahead position. An increasing value represents a clockwise motion with a resolution of 0.1 degrees. A value of 2058 would therefore represent 1 degree clockwise (2058 = 2048 + 10 – but resolution is 0.1 degrees so a value 10 = 1 degree). Values below 2048 represent anticlockwise motion so a value of 1048 would represent an angle 100 degrees anticlockwise of centre.

DATA_TILT_POSITION (Hex 19)

This is a three-byte command. Following the DATA_TILT_POSITION command two data bytes specify the position to which the lamp must move. The bearing resolution is 0.1 degrees. The value is sent LSB first with the first byte representing the lower position command bits. The MSB (sent last) lower 4 bits represents the remaining value. The position value is centred on 2048 (Binary 1000 0000 0000) so a value of 2048 would make the lamp move to the dead ahead position. An increasing value represents tilting up with a resolution of 0.1 degrees. A value of 2058 would therefore represent 1 degree up from dead ahead ($2058 = 2048 + 10$ – but resolution is 0.1 degrees so a value $10 = 1$ degree). Values below 2048 represent tilting down so a value of 1748 would represent an angle 30 degrees down from centre.

LAMP TRANSMITTED DATA

A given lamp after it receives its normal address (Hex 110 to Hex 138) will always send the following data in this specific order. The lamp must transmit its first data byte (pan position) within 1mS of receiving its standard address and the gaps between successive bytes must be less than 1mS.

Lamp TX Byte 1 – Pan position LSB
Lamp TX Byte 2 – Pan position MSB
Lamp TX Byte 3 – Tilt position LSB
Lamp TX Byte 4 – Tilt position MSB
Lamp TX Byte 5 – Lamp status
Lamp TX Byte 6 – CRC

Each byte is described below

Pan Position

This is a 12-bit value with lamp pointing straight ahead being a value of 2048 and the value increasing as the lamp rotates clockwise as viewed from above. The system has a resolution of 0.1 degrees so 90 degrees clockwise from centre would be a value of 2948 ($2048 + 900$).

Tilt position

This is a 12-bit value with lamp horizontal being a value of 2048 and the value increasing as the lamp beam points up. This has a resolution of 0.1 degrees.

Lamp Status

This is an 8-bit value with each bit representing a specific status aspect. The bit functions are listed below; -

Bit 0 - Lamp on
Bit 1 - Pan Limit reached
Bit 2 - Tilt Limit reached
Bit 3 - Lamp Recording
Bit 4 - Lamp Playing
Bit 5 - Lamp Overheated
Bit 6 - Lamp moving to home
Bit 7 - Reserved

The bits are all true logic so if the lamp is switched on, bit 0 will be high.

CRC

The CRC is a simple data checking system. Basically, this is just the sum of the lamps address and bytes above. The value is radix to 8 bits. If the lamp address was 0 (bus address value 16) and the pan and tilt were both at centre and the lamp was switched on and all other status bits were 0 the values would be Hex 110, 80, 80, 01. This would give a CRC value of 11.

Each lamp connected to the bus will always send the data sequence above after it detects its address on the bus. This is basically broadcast information which will be picked up by any panel whose lamp address value matches the currently transmitting lamp address. In this way a panel, which can access more than one lamp, will always update to reflect the status of the currently selected lamp more or less instantly.

EXTERNAL INTERFACE TO LAMPS

Interfacing to FBUS is simple. Any external interface must act as a slave and only send data when given an address slot. The address of an external interface can be any of the panel addresses providing these are not in use by other panels connected to the bus. To receive data from a lamp simply wait for the specific lamps address to be present on the bus then load the next six bytes which will comprise the lamps transmitted data as described above. A detailed description of transmitting and receiving is described below.

TRANSMITTING TO A LAMP

Basically, any sending device mimics a control panel. The full range of panel transmit commands, as described above, can be employed. Data can be sent to any lamp on the system. Two transmit examples are listed below.

EXAMPLE 1

Sending a lamp on/off command using panel 0 address and sending to lamp address 0. Note that the lamp will change switched state each time this command is sent therefore this should only be sent once.

1. Wait for panel address 0 (Hex 100) to be received from the bus.
2. Transmit lamp 0 address (Hex 110) within 1mS. Lamp address 0 is physical address 16 (Hex 10). When a panel sends to a lamp bit 8 is set (hex 100).
3. Send DATA_LAMP_BUTTON Command (Hex value 0A) within 1mS.
4. Send CRC value, in this case Hex 110 + Hex 0A = 11A after radix to 8 bits = 1A. This completes the transmission

EXAMPLE 2

Sending a half speed pan clockwise command using panel 1 address and sending to lamp address 6. – Note that in this example the lamp will continue to pan as long as the command is repeated.

1. Wait for panel address 1 (Hex 101) to be transmitted by the master.
2. Transmit lamp 6 address (Hex 16) within 1mS. Lamp address 6 is physical address 22 (Hex 16).
3. Send DATA_PAN_JOYSTICK Command (Hex value 01) within 1mS.

4. Send pan value half speed = $128 + (64/2) = \text{Hex A0}$ within 1mS.
5. Send CRC value, in this case Hex 116 + Hex 01 + Hex A0 = 1D7 after radix to 8 bits = B7.
6. This completes the transmission

RECEIVING FROM A LAMP

Lamps broadcast data sequentially. There is no need to actively request data to be sent, just wait for the lamps address with bit 7 set to be present on the bus and load the next six bytes. An example is given below; -

EXAMPLE

Obtain lamp number 2 pan position.

1. Listen to the data bus and wait for value Hex 112. (Lamp addresses start at hex 10 so lamp 2 is value 12. Addresses always have bit 8 set so total value is Hex 112).
2. Load the next six bytes from the bus.
3. If desired check the last of the six bytes which is the CRC.
4. Read the two bytes which will be a value centred on 2048 increasing for clockwise from centre and decreasing for anticlockwise. This is lamp number 2 current pan position.

FBUS Speed Control Assembly Status LED Operation

Overview

The FBUS motor control card has a status LED near the centre of the card (labelled 'STATUS'). This has a number of functions as detailed below.

SOFTWARE VERSION

When power is applied to the speed control card the status LED will flash green. The number of flashes corresponds to the software version.

FBUS NORMAL OPERATION

When the system is operating from FBUS the status LED will illuminate static green. When a valid FBUS data signal is received the LED will switch off momentarily to indicate data reception. If data is continuous the LED will flash green slowly.

DMX NORMAL OPERATION

When the system is operating from DMX the status indicator will flash green slowly when DMX data is present. If no DMX data is present the LED will be static green.

OPERATION DURING FAULTS

During faults normal status LED operation is overridden. The status LED will flash red a number times with the number of flashes corresponding to the specific fault. If there are multiple faults the LED will flash accordingly with a gap between each fault flash sequence. Fault details are provided below with the number of flashes indicated on the left.

1. Pan Limit. – Either of the pan limit switches operated. Note that this may not actually be a fault. The LED will flash when a limit switch is operated under normal circumstances i.e. the lamp is at the limit of travel.
2. Tilt Limit. – Either of the tilt limit switches operated. Note that this may not actually be a fault. The LED will flash when a limit switch is operated under normal circumstances i.e. the lamp is at the limit of travel.
3. Pan motor over current. – The pan motor is taking excessive current. The motor will be disabled for a period when this occurs. Fault indication will remain until power is removed.
4. Tilt motor over current. – The tilt motor is taking excessive current. The motor will be disabled for a period when this occurs. Fault indication will remain until power is removed.
5. Focus motor over current. – The focus motor is taking excessive current. The motor will be disabled for a period when this occurs. Fault indication will remain until power is removed.
6. FBUS interface over current. – The speed control card supplies 24VDC to the remote-control panels. This fault indicates the 24VDC output is taking excessive current. The FBUS supply output will switch off. To restore this output, remove the supply from the speed control card for a period.
7. Anti-condensation heater output over current. – The 24VDC anti condensation heater output is taking excessive current. The heater output will switch off. To restore this output, remove the supply from the speed control card for a period.
8. Limit Switch Error. Some lamp types do not use all or some limit switches. If an invalid limit switch input is detected it is probable the speed control card is set to the wrong product or there is a wiring error.
9. Datum Error. The start-up datum system has not completed correctly.
10. Product type not set or corrupt. The product type has not been set, has been set incorrectly or is corrupt.
11. Supply voltage out of tolerance. The 24V supply is outside the range 18-30V.

FBUS INTERFACE UNIT (if supplied)

OVERVIEW

Francis Searchlights FBUS system is designed to allow multiple control panels to manage a number of searchlights on a common data cable. The data system is application specific and, as such, has a fixed data rate and complex timing. The FBUS interface offers a simplified and less time constrained communication interface to the FBUS system over a number of different physical layer communication standards and data rates.

POWER / CONNECTIONS

The interface draws a supply from the FBUS, no external power supply is required. The interface connects to the four-wire FBUS system like any other FBUS system component. The four-wire interface provides a 24V supply and RS485 communications with FBUS.

Connection to the external interfaces will depend on the user's choice of communication system. RS422 (4-wire) RS485 (2-wire) and RS232 are all provided. The RS422 OUT / IN legend on the PCB refers to the data direction from the perspective of the interface unit. The OUT terminals are the interface unit transmit connections. The RS232 connector is configured as a DCE and has all handshake lines looped. No flow control is required. The connections are listed below; -

1. Line signal detect (linked to pins 4 and 6)
2. TX out
3. RX in
4. DTE (linked to pins 1 and 6)
5. 0V
6. DCE Ready (linked to pin 1 and 4)
7. CTS (linked to 8)
8. RTS (linked to 7)
9. No Connection

OPERATOR INTERFACE

The operator interface is very simple with four buttons controlling a single layer menu system on a 2-line LCD display. A given menu item is selected with the SEL (select) button. If the menu item has an adjustable parameter this can be altered using the up and down arrow keys. The revised parameter is stored using the ENT (enter) button. A list of the menu items is provided below; -

MENU ITEMS

DEFAULT DISPLAY

The default display will be active from switch on until the select button is pressed. The default display has no adjustable parameters. The display top line shows the FBUS status. If FBUS is functioning correctly the display top line will show FBUS-ON. The top line of the display also shows the currently selected lamp status i.e. on or off. The default display will indicate if the currently selected lamp is active or not. If the FBUS is working and the

currently selected lamp is responding the bottom line of the display will show the current pan and tilt angles.

SET PANEL ADDRESS

The FBUS interface looks like a standard control panel to the FBUS as such it must have a panel address. The panel address must not be set to the same value as any other panel on the system. Panel addresses start at 0 and go up to 15. Panel addresses should be sequential and start from zero. Once set pressing ENT stores the address.

SET LAMP ADDRESS

The interface unit has menu items (described below) which send commands directly to a given lamp. The default display described above displays data from a given lamp. The set lamp address item is used to define the 'given lamp' address. Lamp addresses start at 16 and go up to 40. This range equates to lamp 0-24 on the lamps address switches.

SET COMMS TYPE

This menu item selects the physical layer communication system for the external interface.

SET DATA RATE

This item selects the data rate for the external interface.

SET DATA CHECKING

This is used to enable or disable received data checking for the external interface. Switching data checking off can be useful during external interface development. Note that this does not affect data checking transmitted to the external interface from the interface unit and does not affect FBUS data checking.

SWITCH LAMP

This is one of the local functions included principally to aid external interface development and verify correct FBUS / lamp operation. Use the arrow keys to select lamp on or lamp off from line 2 of the display. Pressing ENT will send the on or off command to the currently selected lamp (see set lamp address).

SET PAN ANGLE

This command sends a move to pan position command to the currently selected lamp. The pan angle is set using the arrow keys. Pressing enter will make the lamp move to the displayed angle.

SET TILT ANGLE

This command sends a move to tilt position command to the currently selected lamp. The tilt angle is set using the arrow keys. Pressing enter will make the lamp move to the displayed angle.

FOCUS

This function is not implemented on all searchlights. Focus displays the current focus position with a value of 0-100. A value of 50 should represent the most focused beam with the beam diverging above and below 50. Note that the value will ascend from 0-100 the reset back to 0.

Pressing the arrow up button will operate the focus motor.

FAULTS+LIMITS

This displays any faults or limit switch activation relating to the selected lamp. Multiple faults will be displayed sequentially.

LAMP SOFTWARE

This displays the software version of the currently selected lamp

LAMP TYPE No

This displays the lamp type number.

EXT COMMS DATA

This item is included to aid external interface development. The display bottom line will show any valid received commands preceded by the lamp number to which the command is sent. If data checking is enabled the display will indicate if there is a CRC error. The system will also indicate if there has been a bad lamp address or if the command sent is not valid.

FBUS SUPPLY

This just indicates the FBUS supply voltage. FBUS operates at 24V. Values above 30 or below 18 indicate something is wrong.

EXTERNAL DATA INTERFACE – RECEIVED COMMANDS

The external data interface uses command data packets with between four and six bytes including the CRC.

The system uses standard 8-bit data transfer with 1 start bit and 1 stop bit. Data is sent least significant bit (LSB) first.

All data transfer is initiated by the user therefore the system will be inactive until a user transmission.

All data reception must start with a sync byte. The sync byte is value 0xFF.

The next byte is the lamp address. The lamp address is a value between 0x90 and 0xA8. Lamp 0 address would therefore be sent as 0x90. The lamp address indicates which lamp on the system the remaining data is to be directed to.

The next byte is the lamp command. Lamp commands are detailed below.

Some lamp commands have subsequent data bytes.

DATA_FOCUS (0x0B)

This is a four-byte command (Sync, Lamp address, command, CRC). A lamp receiving this will operate its focus motor momentarily. To keep the focus motor running the command must be sent repeatedly.

DATA_MOVE_TO_HOME (0x0C)

This is a four-byte command (Sync, Lamp address, command, CRC). A lamp receiving this will automatically move to the pre-set home position. The command does not need to be maintained while the lamp moves to home. If a home position has not been defined the home position will be straight ahead with the lamp horizontal.

DATA_STORE_HOME (0x 0F)

This is a four-byte command (Sync, Lamp address, command, CRC). A lamp receiving this will store the current pan and tilt position values and will move to these values when the DATA_MOVE_TO_HOME command is issued.

DATA_PAN_CLOCKWISE (0x14)

This is a five-byte command (Sync, Lamp address, command, speed, CRC)
The speed value is between 0 and 127. Value 0 stops pan motion. Increasing values make the lamp move progressively faster. Transmitting codes 0xFF 0x90 0x14 0x7F would make lamp 0 move full speed clockwise.

DATA_PAN_ANTICLOCKWISE (0x15)

This is a five-byte command (Sync, Lamp address, command, speed, CRC)
The speed value is between 0 and 127. Value 0 stops pan motion. Increasing values make the lamp move progressively faster. Transmitting codes Hex 0xFF 0x90 0x15 0x7F would make lamp 0 move full speed anticlockwise.

DATA_TILT_DOWN (0x16)

This is a five-byte command (Sync, Lamp address, command, speed, CRC)
The speed value is between 0 and 127. Value 0 stops tilt motion. Increasing values make the lamp move progressively faster. Transmitting codes Hex 0xFF 0x92 0x16 0x7F would make lamp 2 move down at full speed.

DATA_TILT_UP (0x17)

This is a five-byte command (Sync, Lamp address, command, speed, CRC)
The speed value is between 0 and 127. Value 0 stops tilt motion. Increasing values make the lamp move progressively faster. Transmitting codes Hex 0xFF 0x92 0x17 0x7F would make lamp 2 move up at full speed.

DATA_MOVE_TO_PAN_POSITION (0x18)

This is a six-byte command (Sync, Lamp address, command, position LSB, Position MSB, CRC). The position value is 12 bits and gives a resolution of 0.1 degrees. The most significant byte (sent last) comprises the top 5 bits. The most significant bit (bit 4 – 0b0000x000) determines whether the pan angle is positive (clockwise of centre) or negative (anticlockwise of centre) Bit 4 set to 1 indicates angle is clockwise. The remaining bits will increment as the lamp moves from centre in either direction. The least significant byte comprises the lower 7 bits of the value with the most significant bit set to zero. As an example, a value of 0x0A followed by 0x08 would indicate an angle 1 degree clockwise of centre. 0x0A = 10 but resolution is 0.1 degrees so divide integer value by 10 to give 1.0 degrees. A value of 0x64 followed by 0x00 would indicate a value of 10 degrees anticlockwise of centre.

DATA_MOVE_TO_TILT_POSITION (0x19)

This is a six-byte command (Sync, Lamp address, command, position LSB, Position MSB, CRC). The position value is 12 bits and gives a resolution of 0.1 degrees. The most significant byte (sent last) comprises the top 5 bits. The most significant bit (bit 4 – 0b0000x000) determines whether the tilt angle is positive (tilted up relative to straight ahead) or negative (tilted down relative to straight ahead). Bit 4 set to 1 indicates angle is tilt up. The remaining bits will increment as the lamp moves from centre. The least significant byte comprises the lower 7 bits of the value with the most significant bit set to zero. As an example, a value of 0x0A followed by 0x08 would indicate an angle 1 degree up of centre. 0x0A = 10 but resolution is 0.1 degrees so divide integer value by 10 to give 1.0 degrees. A value of 0x64 followed by 0x00 would indicate a value of 10 degrees down of centre.

DATA_LAMP_ON (0x1A)

This is a four-byte command (Sync, Lamp address, command, CRC). The lamp will switch on when this code is received.

DATA_LAMP_OFF (0x1B)

This is a four-byte command (Sync, Lamp address, command, CRC). The lamp will switch off when this code is received.

DATA_RECORD (0x0D)

This is a four-byte command (Sync, Lamp address, command, CRC). The lamp will start recording motion and lamp on / off data when this code is received.

DATA_PLAY (0x0E)

This is a four-byte command (Sync, Lamp address, command, CRC). The lamp will start playing back a previously recorded sequence when this code is received.

DATA_REQUEST_LAMP_STATUS (0x1E)

This is a four-byte command (Sync, Lamp address, command, CRC). When the interface receives this command, there is a 10mS delay then the interface will switch to transmit and send 13 bytes as detailed below.

1. Sync (FF)
2. Lamp Address with bit 7 set - range 0x90-0xA8
3. Pan Position LSB (Same format as pan position command above)
4. Pan Position MSB
5. Tilt Position LSB (Same format as tilt position command above)
6. Tilt Position MSB
7. Lamp Status
 - Bit 0 - Lamp on
 - Bit 1 - Pan Limit reached
 - Bit 2 - Tilt Limit reached
 - Bit 3 - Lamp Recording
 - Bit 4 - Lamp Playing
 - Bit 5 - Lamp Overheated (not currently implemented)
 - Bit 6 - Lamp moving to home

8. Focus position - Value between 0 and 100 - finest focus at value 50.

9. Fault Status 1

- Bit 0 - Pan motor current high.
- Bit 1 - Tilt motor current high.
- Bit 2 - Focus motor current high.
- Bit 3 - FBUS +24V out current high.
- Bit 4 - Heater current high.

10. Fault Status 2

- Bit 0 - Limit switch error.
- Bit 1 - Datum error.
- Bit 2 - Lamp type invalid.
- Bit 3 - Supply voltage out of tolerance.

11. Lamp software version.

12. Lamp type No.

13. CRC

ERROR CONTROL

Error control is supported by a CRC following each data packet. The CRC is radix to 7 bits with a value between 0 and 127. The CRC is simply the addition of all packets data values including the address and start byte (0xFF). For example, if lamp 0 were commanded to run its focus motor the transmitted data would be; -

0xFF, 0x90, 0x0B. The addition of these values gives 0x19A. The CRC would therefore be this value radix to 7 bits to give a value of 0x1A. this value is the CRC and would be sent as the last byte of the packet.

DATA TIMING

Data packets can be sent up to 10 times per second. Each packet starts with the lamp address which is the only value with bit 8 set. The remaining bytes should follow immediately. The whole packet must be received within 30mS. A packet lasting longer than 30mS will be rejected.

There is no minimum packet send rate. If there is no new data, the system will remain idle.

When the interface unit receives the DATA_REQUEST_LAMP_STATUS command there is a 2-30mS delay after which the interface will switch to transmit and output the 5 data bytes in direct succession. After the last byte has been sent the interface will switch back to receive almost immediately.

7- Fault Finding

All fault finding must be conducted by a competent person or qualified Electrical Engineer.

Please refer to the following table for the trouble-shooting of Xenon lamps.

| Fault | Cause | Remedy |
|--|--|--|
| <ul style="list-style-type: none"> ■ Wrong Polarity | <ul style="list-style-type: none"> ■ Lamp incorrectly fitted ■ Faulty wiring | <ul style="list-style-type: none"> ■ Anode (large electrode) must always be on top in vertical burning position ■ Check polarity, transpose connections if necessary |
| <ul style="list-style-type: none"> ■ Cap overheated ■ Cap temperature above 230°C | <ul style="list-style-type: none"> ■ Faulty contacts ■ Cooling equipment defective | <ul style="list-style-type: none"> ■ Check terminals, tighten or renew ■ Check cooling equipment and replace if necessary |
| <ul style="list-style-type: none"> ■ Arc unsteady | <ul style="list-style-type: none"> ■ Lamp operated outside current control range ■ Magnetic stabilisation for horizontal operation defective | <ul style="list-style-type: none"> ■ Correct current setting ■ Check magnetic stabilisation |
| <ul style="list-style-type: none"> ■ Bulb draws in air | <ul style="list-style-type: none"> ■ Crack in graded seal caused by overheated cap ■ Maximum cap temperature 230°C | <ul style="list-style-type: none"> ■ Check terminals - tighten or renew |
| <ul style="list-style-type: none"> ■ Glass erosion on fused quartz bulb | <ul style="list-style-type: none"> ■ Lamp operated outside current control range ■ Lamp service life exceeded | <ul style="list-style-type: none"> ■ Correct current setting ■ Check meter |
| <ul style="list-style-type: none"> ■ Electrodes damaged ■ Premature blackening | <ul style="list-style-type: none"> ■ Current ripple too high ■ Auxiliary mirror incorrectly adjusted | <ul style="list-style-type: none"> ■ Have power supply inspected ■ Adjust auxiliary mirror |
| <ul style="list-style-type: none"> ■ Asymmetrical blackening of lamp (in horizontal burning position) | <ul style="list-style-type: none"> ■ Lamp operated too long in same position | <ul style="list-style-type: none"> ■ Turn lamp through 180° after half service life |

Failure of Lamp to Ignite

In the event of the xenon lamp failing to light the following steps should be taken:

- 1) Check that the mains supply is connected to the input of the PSU. On operating the lamp switch, if the lamp does not light, switch off mains supply and check all fuses;
- 2) On pressing the lamp switch the lamp still does not ignite, check the searchlight head. On your command get an operator to activate the switch for approximately 10 seconds. During this time listen for any noise (cracking or hissing) coming from within the barrel. If this arcing is heard switch off the supply at the mains. Remove the rear bezel to expose the two supply leads to the xenon lamp. Using a dry cloth wipe these leads to remove any dust, moisture or condensation that may have formed around the inside of the barrel. Replace the rear bezel, ensuring the latches are located, and perform the check again, listening for the cracking. If the lamp still fails to ignite, switch off at the mains and replace the xenon lamp in accordance with the safety procedures within this manual and the manufacturer's information.

Any further tests to be carried out with regards to lamp failure must be conducted by a competent electrical engineer and should not be carried out in an explosive atmosphere.

- 3) Before a xenon lamp will ignite, the electrically insulated gas between the electrodes must be ionised. This is done by the ignitor which produces a high frequency voltage (up to 40,000 volts or higher). The ignitor is activated by switching the lamp on and a crackling or hissing noise should be heard. The ignitor is housed within the rear of the searchlight barrel. This is a totally encapsulated unit and repair is not advised. If found to be faulty a new ignitor must be fitted.

Failure of Remote Focus Facility

The remote focus mechanism is controlled by a small electric motor situated at the rear of the searchlight barrel. If the focus of the light fails, the following procedure should be adopted:

- 1) Remove the rear bezel from searchlight barrel and examine focus mechanism. If parts have become loose, tighten fasteners. The mechanism operates on a lever action and this should be checked for correct positioning;
- 2) If the mechanism is okay, check the supply to the motor. This can be done by simply placing a multi-meter across the motor terminals;
- 3) If supply is present, this indicates that the motor has failed. Replace the focus motor ensuring that the assembly is correct;
- 4) If no supply is present, there is a fault in the motor gearbox. This should be examined and rectified accordingly.

Note: If a fault occurs on the motor gearbox, the unit should be returned to Francis Searchlights Limited for fault evaluation and repair.

8 - Maintenance and Servicing

In order to prolong the service life and performance of your searchlight, the following maintenance guidelines are recommended:

- Maintenance checks should be conducted before every voyage or at least every three months;
- Before checking, disconnect the equipment from the supply;
- Visually inspect the condition of the equipment;
- Any major or minor structural damage should be rectified immediately in order to reduce sympathetic wear;
- After inspection it may be necessary to clean the inside of the searchlight. The following procedure should be adhered to:
 - Remove the front bezel;
 - Clean the front glass inside and out using a proprietary glass cleaner;
 - Clean the reflector if required;
 - Check the reflector mounting gaskets. If signs of corrosion or damage are evident, replace as necessary;
 - Ensure that the lampholder is free from corrosion or other damage;
 - Check earth point for conductivity;
- It is advisable to check all seals and gaskets for signs of degradation. Renew if necessary;
- Upon completing all maintenance requirements, the searchlight should be tested for full working order (approximately 20 minutes).

If in any doubt as to the correct servicing procedures to adopt, please contact your distributor/agent or the manufacturer who will be able to advise the best course of action for your product.

9 - Wiring Diagram and General Assembly

| Drawing Number | Description |
|-----------------------|--|
| C27405 | Wiring Diagram Xenon 1Kw RC Variable speed |
| A7162 / A7161 | General Assembly drawing |
| C27312 | Joystick Panel Assembly |
| C26736 | Junction Box Assembly |
| C26822 / C26823 | Power Supply Enclosure Assembly |

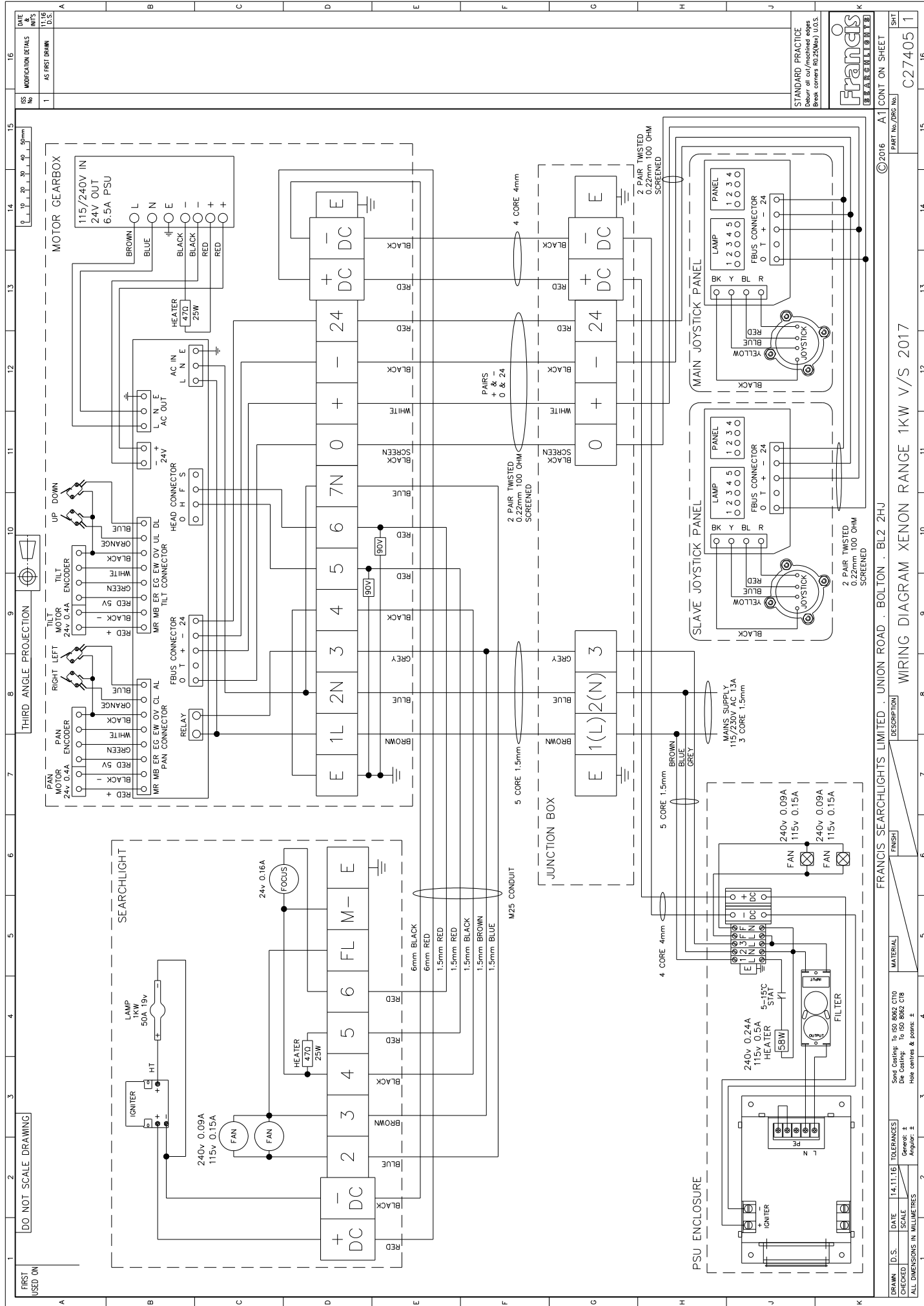

| | |
|----------------------|----|
| DATE & MODS | 16 |
| NOTES | |
| MODIFICATION DETAILS | |
| NO | 1 |
| AS FIRST DRAWN | |

STANDARD PRACTICE
Debur all cut/machined edges
Break corners R0.25(Max) U.O.S.

Francis
FRANCIS SEARCHLIGHTS LIMITED

© 2016 A1 CONT ON SHEET

PART No./REV No

SHT
C27405 1

| | | | | | | | | | | | | | | | | |
|------------------------------|----------------------|------------------------|----------------------------|-----------------------------|---|-------------------------|----------------------|---|----------------------|-----------------------|----------------------|------------------------|-------------------------------|----------------------|----------------------|----------|
| 1 | 2 | 3 | 4 | 5 | 6 | 7 | 8 | 9 | 10 | 11 | 12 | 13 | 14 | 15 | 16 | |
| FIRST USED ON | DO NOT SCALE DRAWING | THIRD ANGLE PROJECTION | PAN MOTOR 24v 0.4A ENCODER | TILT MOTOR 24v 0.4A ENCODER | RIGHT LEFT ENCODER 24v 0.4A | MR MB ER EG EV OY UL DL | RELAY | FAN MOTOR 24v 0.4A | PAN ENCODER 24v 0.4A | TILT ENCODER 24v 0.4A | UP DOWN | THIRD ANGLE PROJECTION | HEATER 470 25W | 115/240V IN | 24V OUT | 6.5A PSU |
| SEARCHLIGHT | SEARCHLIGHT | SEARCHLIGHT | SEARCHLIGHT | SEARCHLIGHT | SEARCHLIGHT | SEARCHLIGHT | SEARCHLIGHT | SEARCHLIGHT | SEARCHLIGHT | SEARCHLIGHT | SEARCHLIGHT | SEARCHLIGHT | SEARCHLIGHT | SEARCHLIGHT | SEARCHLIGHT | |
| JUNCTION BOX | JUNCTION BOX | JUNCTION BOX | JUNCTION BOX | JUNCTION BOX | JUNCTION BOX | JUNCTION BOX | JUNCTION BOX | JUNCTION BOX | JUNCTION BOX | JUNCTION BOX | JUNCTION BOX | JUNCTION BOX | JUNCTION BOX | JUNCTION BOX | JUNCTION BOX | |
| MOTOR GEARBOX | MOTOR GEARBOX | MOTOR GEARBOX | MOTOR GEARBOX | MOTOR GEARBOX | MOTOR GEARBOX | MOTOR GEARBOX | MOTOR GEARBOX | MOTOR GEARBOX | MOTOR GEARBOX | MOTOR GEARBOX | MOTOR GEARBOX | MOTOR GEARBOX | MOTOR GEARBOX | MOTOR GEARBOX | MOTOR GEARBOX | |
| SLAVE JOYSTICK PANEL | SLAVE JOYSTICK PANEL | SLAVE JOYSTICK PANEL | SLAVE JOYSTICK PANEL | SLAVE JOYSTICK PANEL | SLAVE JOYSTICK PANEL | SLAVE JOYSTICK PANEL | SLAVE JOYSTICK PANEL | SLAVE JOYSTICK PANEL | SLAVE JOYSTICK PANEL | SLAVE JOYSTICK PANEL | SLAVE JOYSTICK PANEL | SLAVE JOYSTICK PANEL | SLAVE JOYSTICK PANEL | SLAVE JOYSTICK PANEL | SLAVE JOYSTICK PANEL | |
| MAIN JOYSTICK PANEL | MAIN JOYSTICK PANEL | MAIN JOYSTICK PANEL | MAIN JOYSTICK PANEL | MAIN JOYSTICK PANEL | MAIN JOYSTICK PANEL | MAIN JOYSTICK PANEL | MAIN JOYSTICK PANEL | MAIN JOYSTICK PANEL | MAIN JOYSTICK PANEL | MAIN JOYSTICK PANEL | MAIN JOYSTICK PANEL | MAIN JOYSTICK PANEL | MAIN JOYSTICK PANEL | MAIN JOYSTICK PANEL | MAIN JOYSTICK PANEL | |
| PSU ENCLOSURE | PSU ENCLOSURE | PSU ENCLOSURE | PSU ENCLOSURE | PSU ENCLOSURE | PSU ENCLOSURE | PSU ENCLOSURE | PSU ENCLOSURE | PSU ENCLOSURE | PSU ENCLOSURE | PSU ENCLOSURE | PSU ENCLOSURE | PSU ENCLOSURE | PSU ENCLOSURE | PSU ENCLOSURE | PSU ENCLOSURE | |
| FRANCIS SEARCHLIGHTS LIMITED | UNION ROAD | BOLTON | BL2 2HU | DESCRIPTION | WIRING DIAGRAM XENON RANGE 1KW V/S 2017 | TINISH | MATERIAL | 5mm Spacing to ISO 898 C19 Drill Centre to ISO 898 C18 Hole centres & posns ± | TOLERANCES | ± | SCALE | 1:1 | ALL DIMENSIONS IN MICROMETRES | DATE | 14.11.16 | |

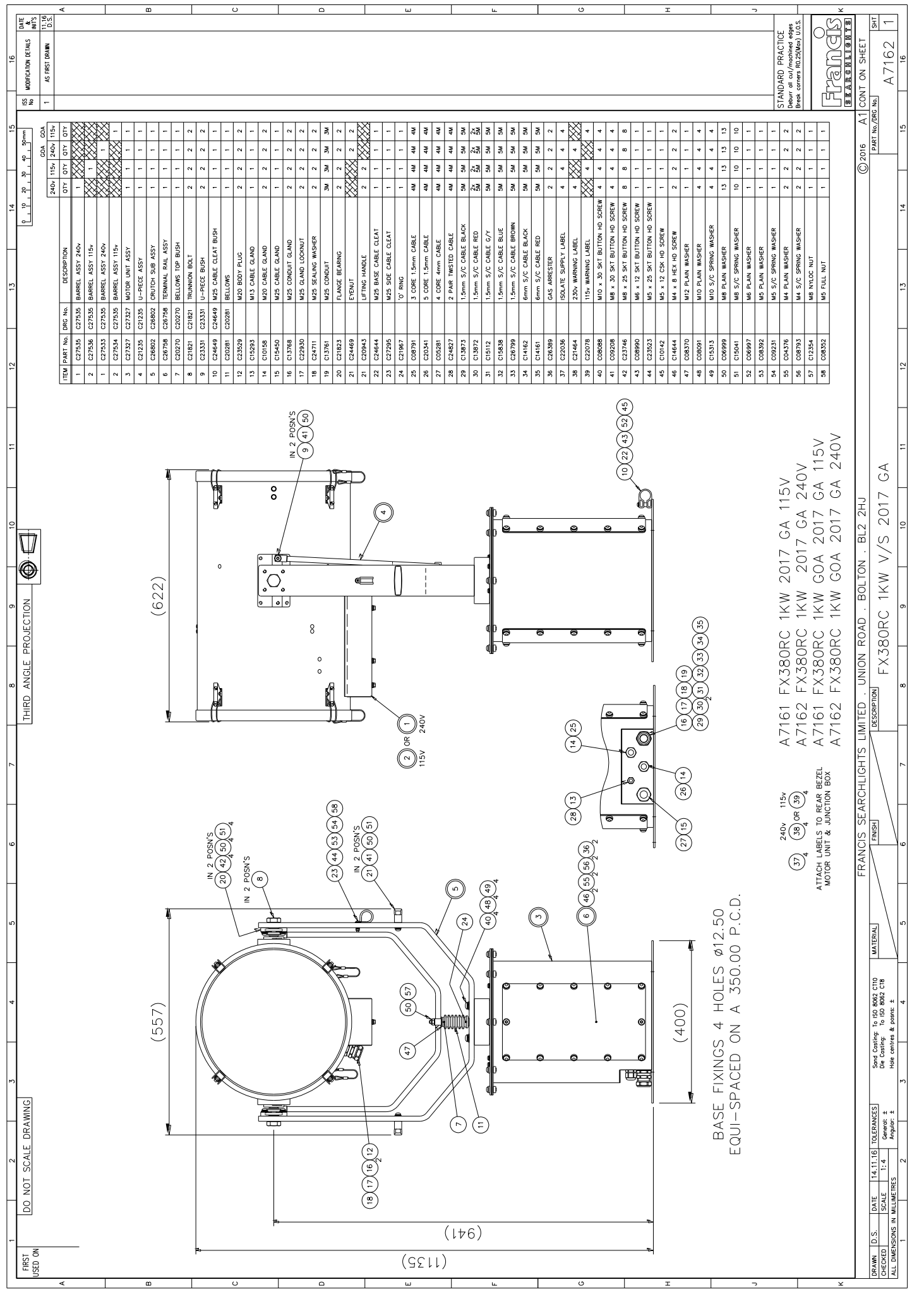

| ITEM | PART No. | QTY | DESCRIPTION | QTY | 115v | 240v | GOA |
|------|----------|-----|------------------------------|-----|------|------|-----|
| 1 | C27535 | 1 | BARREL ASSY 240v | 1 | | | |
| 2 | C27536 | 1 | BARREL ASSY 115v | 1 | | | |
| 1 | C27533 | 1 | BARREL ASSY 240v | 1 | | | |
| 2 | C27534 | 1 | BARREL ASSY 115v | 1 | | | |
| 3 | C27327 | 1 | MOTOR UNIT ASSY | 1 | | | |
| 4 | C21235 | 1 | U-PIECE ASSY | 1 | | | |
| 5 | C24802 | 1 | CRITCH SUB ASSY | 1 | | | |
| 6 | C26758 | 1 | TERMINAL RAIL ASSY | 1 | | | |
| 7 | C20270 | 1 | BELLOWS TOP BUSH | 1 | | | |
| 8 | C21821 | 1 | TRIMMING BOLT | 1 | | | |
| 9 | C23331 | 2 | U-PIECE BUSH | 2 | | | |
| 10 | C24648 | 1 | M25 CABLE CLEAT BUSH | 1 | | | |
| 11 | C20281 | 1 | BELLOWS | 1 | | | |
| 12 | C23359 | 2 | M20 BODY PLUG | 2 | | | |
| 13 | C15293 | 1 | M13 CABLE GLAND | 1 | | | |
| 14 | C10158 | 2 | M20 CABLE GLAND | 2 | | | |
| 15 | C15450 | 1 | M25 CABLE GLAND | 1 | | | |
| 16 | C13768 | 2 | M25 CONDUIT GLAND | 2 | | | |
| 17 | C22830 | 2 | M25 GLAND LOCKNUT | 2 | | | |
| 18 | C13761 | 2 | M25 SEALING WASHER | 2 | | | |
| 19 | C13761 | 3M | M25 CONDUIT | 3M | | | |
| 20 | C21823 | 2 | FLANGE BEARING | 2 | | | |
| 21 | C24469 | 2 | EYE NUT | 2 | | | |
| 22 | C20943 | 2 | LIFTING HANDLE | 2 | | | |
| 23 | C24644 | 1 | M25 BASE CABLE CLEAT | 1 | | | |
| 24 | C27295 | 1 | M25 SIDE CABLE CLEAT | 1 | | | |
| 25 | C21967 | 1 | 'O' RING | 1 | | | |
| 26 | C20341 | 4M | 3 CORE 1.5mm CABLE | 4M | | | |
| 27 | C05281 | 4M | 5 CORE 1.5mm CABLE | 4M | | | |
| 28 | C24827 | 4M | 4 CORE 4mm CABLE | 4M | | | |
| 29 | C13673 | 2 | 2 PAIR TWISTED CABLE | 4M | | | |
| 30 | C13672 | 5M | 1.5mm S/C CABLE BLACK | 5M | | | |
| 31 | C15112 | 5M | 1.5mm S/C CABLE RED | 5M | | | |
| 32 | C15838 | 5M | 1.5mm S/C CABLE C/Y | 5M | | | |
| 33 | C26799 | 5M | 1.5mm S/C CABLE BLUE | 5M | | | |
| 34 | C14162 | 5M | 1.5mm S/C CABLE BROWN | 5M | | | |
| 35 | C14161 | 5M | 6mm S/C CABLE BLACK | 5M | | | |
| 36 | C26389 | 5M | 6mm S/C CABLE RED | 5M | | | |
| 37 | C22056 | 2 | GAS ARRESTER | 2 | | | |
| 38 | C21464 | 4 | ISOLATE SUPPLY LABEL | 4 | | | |
| 39 | C22078 | 4 | 230v WARNING LABEL | 4 | | | |
| 40 | C08088 | 4 | 115v WARNING LABEL | 4 | | | |
| 41 | C09208 | 4 | M10 x 30 SKT BUTTON HD SCREW | 4 | | | |
| 42 | C23746 | 4 | M8 x 30 SKT BUTTON HD SCREW | 4 | | | |
| 43 | C08990 | 8 | M8 x 25 SKT BUTTON HD SCREW | 8 | | | |
| 44 | C23523 | 1 | M5 x 25 SKT BUTTON HD SCREW | 1 | | | |
| 45 | C10142 | 1 | M5 x 12 CSK HD SCREW | 1 | | | |
| 46 | C14644 | 2 | M4 x 8 HEX HD SCREW | 2 | | | |
| 47 | C08370 | 1 | M12 PLAIN WASHER | 1 | | | |
| 48 | C08091 | 4 | M10 PLAIN WASHER | 4 | | | |
| 49 | C15313 | 4 | M10 S/C SPRING WASHER | 4 | | | |
| 50 | C08999 | 13 | M8 PLAIN WASHER | 13 | | | |
| 51 | C15041 | 10 | M8 S/C SPRING WASHER | 10 | | | |
| 52 | C08977 | 1 | M6 PLAIN WASHER | 1 | | | |
| 53 | C08302 | 1 | M5 PLAIN WASHER | 1 | | | |
| 54 | C09231 | 1 | M5 S/C SPRING WASHER | 1 | | | |
| 55 | C04376 | 2 | M4 PLAIN WASHER | 2 | | | |
| 56 | C08793 | 2 | M4 S/C SPRING WASHER | 2 | | | |
| 57 | C12854 | 1 | M8 NYLOC NUT | 1 | | | |
| 58 | C08325 | 1 | M5 FULL NUT | 1 | | | |

| DATE | DESCRIPTION | BY | CHKD |
|------|----------------|----|------|
| 16 | AS FIRST DRAWN | | |

STANDARD PRACTICE
Debur all cut/machined edges
Break corners R0.25(Min) U.O.S.

© 2016 A1 CONT. ON SHEET
PART No./ORG No. A7162 1

FRANCIS SEARCHLIGHTS LIMITED UNION ROAD . BOLTON . BL2 2HU

DESCRIPTION: A7161 FX380RC 1KW 2017 GA 115V
A7162 FX380RC 1KW 2017 GA 240V
A7161 FX380RC 1KW GOA 2017 GA 115V
A7162 FX380RC 1KW GOA 2017 GA 240V

FINISH: MATERIAL: FX380RC 1KW V/S 2017 GA

Base Fixings 4 Holes ϕ 12.50
EQUI-SPACED ON A 350.00 P.C.D.

ATTACH LABELS TO REAR BEZEL
MOTOR UNIT & JUNCTION BOX

FRANCIS SEARCHLIGHTS LIMITED UNION ROAD . BOLTON . BL2 2HU

DESCRIPTION: A7161 FX380RC 1KW 2017 GA 115V
A7162 FX380RC 1KW 2017 GA 240V
A7161 FX380RC 1KW GOA 2017 GA 115V
A7162 FX380RC 1KW GOA 2017 GA 240V

FINISH: MATERIAL: FX380RC 1KW V/S 2017 GA

Base Fixings 4 Holes ϕ 12.50
EQUI-SPACED ON A 350.00 P.C.D.

ATTACH LABELS TO REAR BEZEL
MOTOR UNIT & JUNCTION BOX

FRANCIS SEARCHLIGHTS LIMITED UNION ROAD . BOLTON . BL2 2HU

DESCRIPTION: A7161 FX380RC 1KW 2017 GA 115V
A7162 FX380RC 1KW 2017 GA 240V
A7161 FX380RC 1KW GOA 2017 GA 115V
A7162 FX380RC 1KW GOA 2017 GA 240V

FINISH: MATERIAL: FX380RC 1KW V/S 2017 GA

Base Fixings 4 Holes ϕ 12.50
EQUI-SPACED ON A 350.00 P.C.D.

ATTACH LABELS TO REAR BEZEL
MOTOR UNIT & JUNCTION BOX

FRANCIS SEARCHLIGHTS LIMITED UNION ROAD . BOLTON . BL2 2HU

DESCRIPTION: A7161 FX380RC 1KW 2017 GA 115V
A7162 FX380RC 1KW 2017 GA 240V
A7161 FX380RC 1KW GOA 2017 GA 115V
A7162 FX380RC 1KW GOA 2017 GA 240V

FINISH: MATERIAL: FX380RC 1KW V/S 2017 GA

Base Fixings 4 Holes ϕ 12.50
EQUI-SPACED ON A 350.00 P.C.D.

ATTACH LABELS TO REAR BEZEL
MOTOR UNIT & JUNCTION BOX

FRANCIS SEARCHLIGHTS LIMITED UNION ROAD . BOLTON . BL2 2HU

DESCRIPTION: A7161 FX380RC 1KW 2017 GA 115V
A7162 FX380RC 1KW 2017 GA 240V
A7161 FX380RC 1KW GOA 2017 GA 115V
A7162 FX380RC 1KW GOA 2017 GA 240V

FINISH: MATERIAL: FX380RC 1KW V/S 2017 GA

Base Fixings 4 Holes ϕ 12.50
EQUI-SPACED ON A 350.00 P.C.D.

ATTACH LABELS TO REAR BEZEL
MOTOR UNIT & JUNCTION BOX

FRANCIS SEARCHLIGHTS LIMITED UNION ROAD . BOLTON . BL2 2HU

DESCRIPTION: A7161 FX380RC 1KW 2017 GA 115V
A7162 FX380RC 1KW 2017 GA 240V
A7161 FX380RC 1KW GOA 2017 GA 115V
A7162 FX380RC 1KW GOA 2017 GA 240V

FINISH: MATERIAL: FX380RC 1KW V/S 2017 GA

Base Fixings 4 Holes ϕ 12.50
EQUI-SPACED ON A 350.00 P.C.D.

ATTACH LABELS TO REAR BEZEL
MOTOR UNIT & JUNCTION BOX

FRANCIS SEARCHLIGHTS LIMITED UNION ROAD . BOLTON . BL2 2HU

DESCRIPTION: A7161 FX380RC 1KW 2017 GA 115V
A7162 FX380RC 1KW 2017 GA 240V
A7161 FX380RC 1KW GOA 2017 GA 115V
A7162 FX380RC 1KW GOA 2017 GA 240V

FINISH: MATERIAL: FX380RC 1KW V/S 2017 GA

| | | | |
|----------------------|----------------|---------------|------------|
| ISS No | 1 | DATE & INIT'S | 10.16 D.S. |
| MODIFICATION DETAILS | AS FIRST DRAWN | | |

| | |
|-------------------|--|
| STANDARD PRACTICE | Deburr all cut/machined edges Break corners R0.25(Max) U.O.S. |
|-------------------|--|

| | | |
|-------|----|---------------|
| ©2016 | A2 | CONT ON SHEET |
|-------|----|---------------|

| | |
|----------------------|--|
| FRANCIS SEARCHLIGHTS | |
|----------------------|--|

| | |
|-----|---|
| SHT | 1 |
|-----|---|

| | |
|------------------|--------|
| PART No./DRG No. | C27312 |
|------------------|--------|

| | |
|-------------|------------------------------------|
| DESCRIPTION | 3 BUTTON CONTROL PANEL ASSY (2017) |
|-------------|------------------------------------|

| | |
|--------|--|
| FINISH | |
|--------|--|

| | |
|----------|--|
| MATERIAL | |
|----------|--|

| | | | |
|------------------------------|------------|--------|---------|
| FRANCIS SEARCHLIGHTS LIMITED | UNION ROAD | BOLTON | BL2 2HU |
|------------------------------|------------|--------|---------|

| | | | | | |
|------|------|------|-------|------------|--------------------------------|
| DRWN | D.S. | DATE | 10.16 | TOLERANCES | Sand Casting: To ISO 8062 CT10 |
|------|------|------|-------|------------|--------------------------------|

| | | | | |
|---------|-------|-----|------------|------------------------------|
| CHECKED | SCALE | 1:1 | General: ± | Die Casting: To ISO 8062 C18 |
|---------|-------|-----|------------|------------------------------|

| | |
|-------------------------------|-------------------------|
| ALL DIMENSIONS IN MILLIMETRES | Hole centres & posns: ± |
|-------------------------------|-------------------------|

| | | | | | | | | | | |
|---|---|---|---|---|---|---|---|---|----|----|
| 1 | 2 | 3 | 4 | 5 | 6 | 7 | 8 | 9 | 10 | 11 |
|---|---|---|---|---|---|---|---|---|----|----|

| | |
|----------------------|------------------------|
| DO NOT SCALE DRAWING | THIRD ANGLE PROJECTION |
|----------------------|------------------------|

| | |
|---------------|--|
| FIRST USED ON | |
|---------------|--|

| | | | | | | | | | | |
|---|---|---|---|---|---|---|---|---|----|----|
| 1 | 2 | 3 | 4 | 5 | 6 | 7 | 8 | 9 | 10 | 11 |
|---|---|---|---|---|---|---|---|---|----|----|

| | | | | | | | | | | |
|---|---|---|---|---|---|---|---|---|----|----|
| 1 | 2 | 3 | 4 | 5 | 6 | 7 | 8 | 9 | 10 | 11 |
|---|---|---|---|---|---|---|---|---|----|----|

| | | | | | | | | | | |
|---|---|---|---|---|---|---|---|---|----|----|
| 1 | 2 | 3 | 4 | 5 | 6 | 7 | 8 | 9 | 10 | 11 |
|---|---|---|---|---|---|---|---|---|----|----|

| | | | | | | | | | | |
|---|---|---|---|---|---|---|---|---|----|----|
| 1 | 2 | 3 | 4 | 5 | 6 | 7 | 8 | 9 | 10 | 11 |
|---|---|---|---|---|---|---|---|---|----|----|

| | | | | | | | | | | |
|---|---|---|---|---|---|---|---|---|----|----|
| 1 | 2 | 3 | 4 | 5 | 6 | 7 | 8 | 9 | 10 | 11 |
|---|---|---|---|---|---|---|---|---|----|----|

| | | | | | | | | | | |
|---|---|---|---|---|---|---|---|---|----|----|
| 1 | 2 | 3 | 4 | 5 | 6 | 7 | 8 | 9 | 10 | 11 |
|---|---|---|---|---|---|---|---|---|----|----|

| | | | | | | | | | | |
|---|---|---|---|---|---|---|---|---|----|----|
| 1 | 2 | 3 | 4 | 5 | 6 | 7 | 8 | 9 | 10 | 11 |
|---|---|---|---|---|---|---|---|---|----|----|

| | | | | | | | | | | |
|---|---|---|---|---|---|---|---|---|----|----|
| 1 | 2 | 3 | 4 | 5 | 6 | 7 | 8 | 9 | 10 | 11 |
|---|---|---|---|---|---|---|---|---|----|----|

| | | | | | | | | | | |
|---|---|---|---|---|---|---|---|---|----|----|
| 1 | 2 | 3 | 4 | 5 | 6 | 7 | 8 | 9 | 10 | 11 |
|---|---|---|---|---|---|---|---|---|----|----|

| | | | | | | | | | | |
|---|---|---|---|---|---|---|---|---|----|----|
| 1 | 2 | 3 | 4 | 5 | 6 | 7 | 8 | 9 | 10 | 11 |
|---|---|---|---|---|---|---|---|---|----|----|

| | | | | | | | | | | |
|---|---|---|---|---|---|---|---|---|----|----|
| 1 | 2 | 3 | 4 | 5 | 6 | 7 | 8 | 9 | 10 | 11 |
|---|---|---|---|---|---|---|---|---|----|----|

| | | | | | | | | | | |
|---|---|---|---|---|---|---|---|---|----|----|
| 1 | 2 | 3 | 4 | 5 | 6 | 7 | 8 | 9 | 10 | 11 |
|---|---|---|---|---|---|---|---|---|----|----|

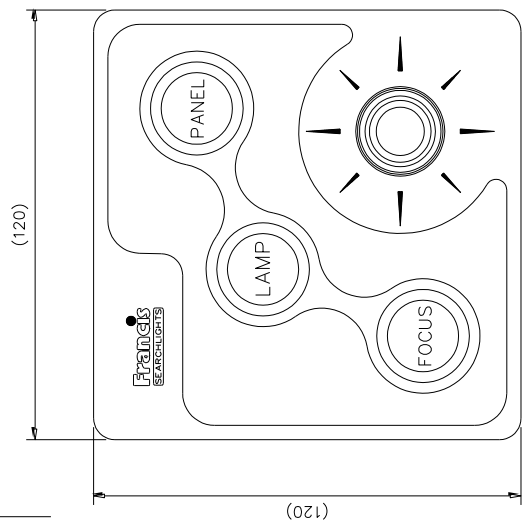
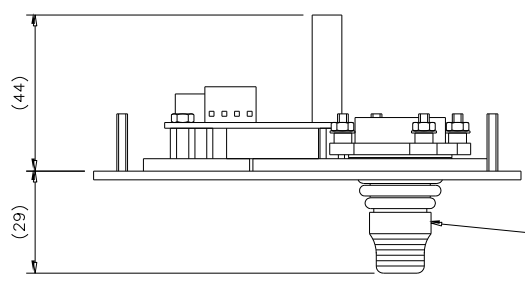
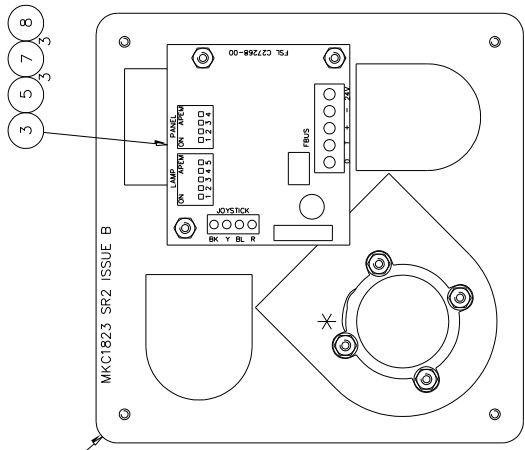

CUT-OUT DETAILS

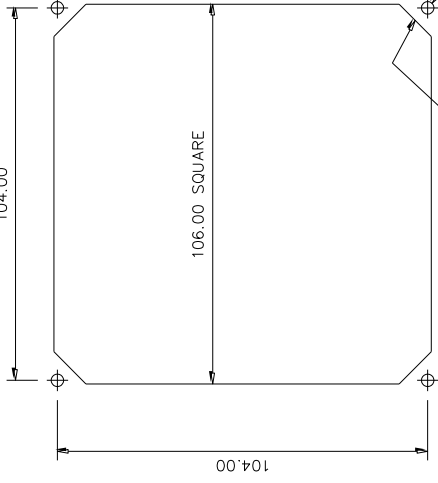

NOTES
 OPEN JOYSTICK BEZEL HOLES TO ø3.40.
 POSITION ITEM 4 UNDER THE JOYSTICK BELLOWS.
 POSITION THE JOYSTICK WITH THE INDICATOR AT THE TOP AS SHOWN * & CLAMPING RING NOTCH TO THE RIGHT DO NOT OVER TIGHTEN THE NUTS.

| ITEM | PART No. | DRG No. | DESCRIPTION | QTY |
|------|----------|---------|-------------------------|-----|
| 1 | C26528 | C26528 | CONTROL PANEL 3 BUTTON | 1 |
| 2 | C26537 | | JOYSTICK | 1 |
| 3 | C27268 | | CONTROL PANEL INTERFACE | 1 |
| 4 | C24710 | | M20 SEALING WASHER | 1 |
| 5 | C27020 | | SPACER | 3 |
| 6 | C08028 | | M3 PLAIN WASHER | 4 |
| 7 | C05298 | | M3 FULL NUT | 7 |
| 8 | C13853 | | LOCTITE TL42 | A/R |

FIRST USED ON
QLOZY
KENOX

DO NOT SCALE DRAWING

THIRD ANGLE PROJECTION

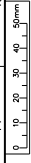

| | | |
|----|----------------------|----------|
| 16 | DATE | 16.11.15 |
| 15 | MODIFICATION DETAILS | |
| 14 | AS FIRST DRAWN | |
| 13 | D.S. | |

| ITEM | PART No. | DRG No. | DESCRIPTION | QTY |
|------|----------|---------|----------------------|-----|
| 1 | C26737 | C26737 | TERMINAL RAIL ASSY | 1 |
| 2 | C20230 | C20230 | CHASSIS PLATE ASSY | 1 |
| 3 | C26735 | C26735 | ENCLOSURE DRILLING | 1 |
| 4 | C15450 | | M25 CABLE GLAND | 2 |
| 5 | C12415 | | M20 CABLE GLAND | 4 |
| 6 | C15293 | | M13 CABLE GLAND | 2 |
| 7 | C09695 | | M5 x 10 PAN HD SCREW | 2 |
| 8 | C23598 | | #4 x 8 PAN HD SCREW | 4 |
| 9 | C08392 | | M5 PLAIN WASHER | 2 |

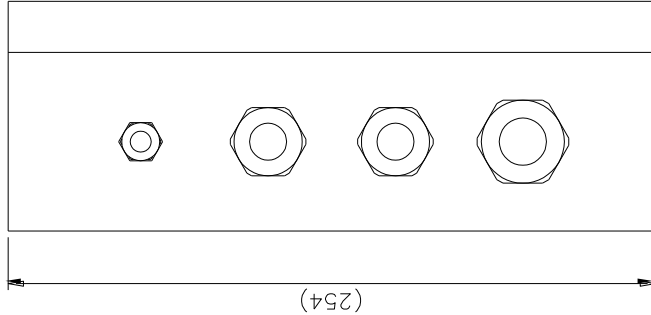
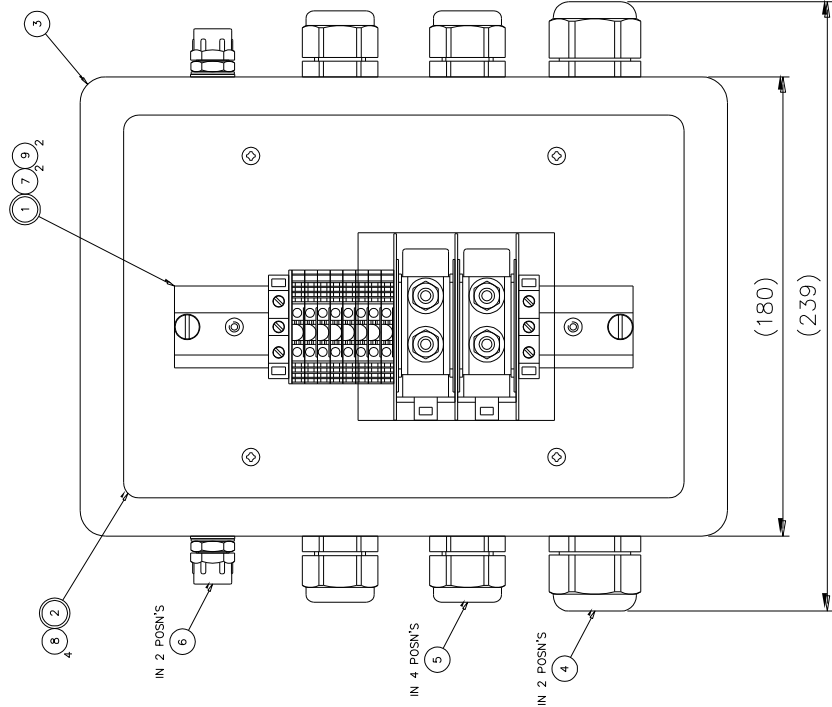
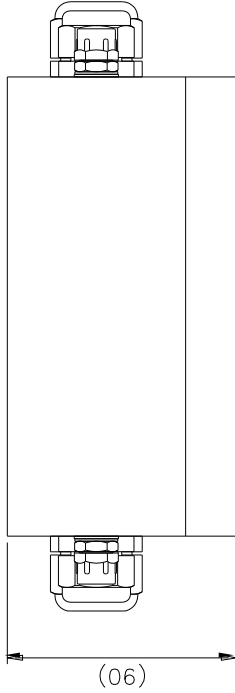

STANDARD PRACTICE
Reference to ISO 8892, C10
Use Casting to ISO 8862, C16
Note centres & posns. 1

Francis
SEARCHLIGHTS LIMITED

©2015 A1 CONT ON SHEET
PART No./DRG No. C26736 1
SHT 1

FRANCIS SEARCHLIGHTS LIMITED · UNION ROAD · BOLTON · BL2 2HU

JUNCTION BOX ASSY

FINISH DESCRIPTION

MATERIAL

Sand Casting to ISO 8892 C10
Die Casting to ISO 8862 C16
Note centres & posns. 1

TOOLERANCES
General: ±
Angular: ±

DATE 16.2.15
SCALE 1:1
ALL DIMENSIONS IN MILLIMETRES

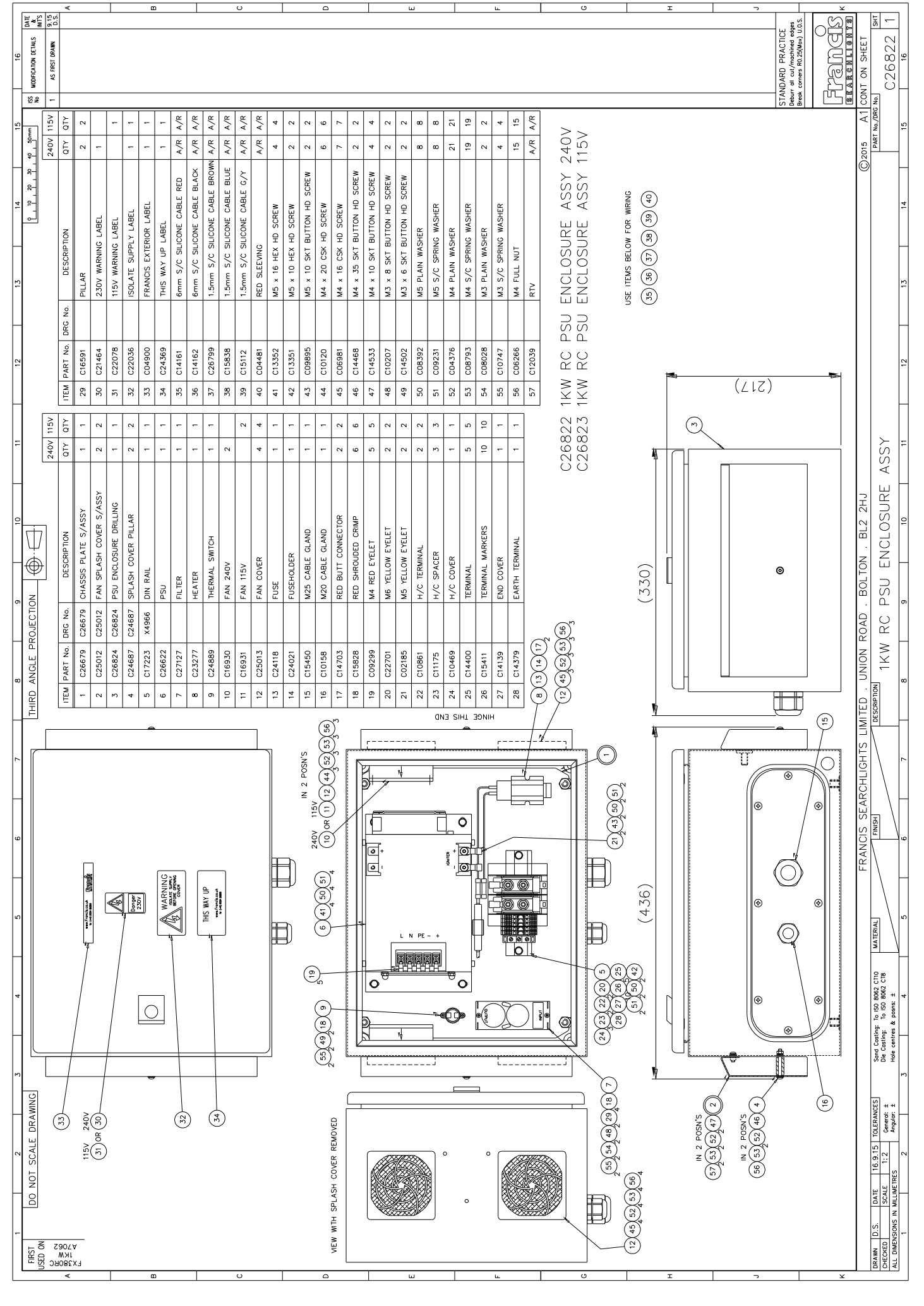

| DATE | DESCRIPTION | BY | CHKD | APP'D |
|------|----------------------|----|------|-------|
| 16 | MODIFICATION DETAILS | | | |
| 15 | AS FIRST DRAWN | | | |

| ITEM | PART No. | DRG No. | DESCRIPTION | QTY | 240V | 115V |
|------|----------|---------|--------------------------------|-----|------|------|
| 29 | C16591 | | PILLAR | 2 | 2 | 2 |
| 30 | C21464 | | 230V WARNING LABEL | 1 | | |
| 31 | C22078 | | 115V WARNING LABEL | 1 | | |
| 32 | C22036 | | ISOLATE SUPPLY LABEL | 1 | | |
| 33 | C04900 | | FRANCIS EXTERIOR LABEL | 1 | | |
| 34 | C24369 | | THIS WAY UP LABEL | 1 | | |
| 35 | C14161 | | 6mm S/C SILICONE CABLE RED | A/R | A/R | A/R |
| 36 | C14162 | | 6mm S/C SILICONE CABLE BLACK | A/R | A/R | A/R |
| 37 | C26799 | | 1.5mm S/C SILICONE CABLE BROWN | A/R | A/R | A/R |
| 38 | C15838 | | 1.5mm S/C SILICONE CABLE BLUE | A/R | A/R | A/R |
| 39 | C15112 | | 1.5mm S/C SILICONE CABLE G/Y | A/R | A/R | A/R |
| 40 | C04481 | | RED SLEEVING | A/R | A/R | A/R |
| 41 | C13352 | | M5 x 16 HEX HD SCREW | 4 | 4 | 4 |
| 42 | C13351 | | M5 x 10 HEX HD SCREW | 2 | 2 | 2 |
| 43 | C09895 | | M5 x 10 SKT BUTTON HD SCREW | 2 | 2 | 2 |
| 44 | C10207 | | M4 x 20 CSK HD SCREW | 6 | 6 | 6 |
| 45 | C06981 | | M4 x 16 CSK HD SCREW | 7 | 7 | 7 |
| 46 | C14468 | | M4 x 35 SKT BUTTON HD SCREW | 2 | 2 | 2 |
| 47 | C14533 | | M4 x 10 SKT BUTTON HD SCREW | 4 | 4 | 4 |
| 48 | C10207 | | M3 x 8 SKT BUTTON HD SCREW | 2 | 2 | 2 |
| 49 | C14502 | | M3 x 6 SKT BUTTON HD SCREW | 2 | 2 | 2 |
| 50 | C08392 | | M5 PLAIN WASHER | 8 | 8 | 8 |
| 51 | C09231 | | M5 S/C SPRING WASHER | 8 | 8 | 8 |
| 52 | C04376 | | M4 PLAIN WASHER | 21 | 21 | 21 |
| 53 | C08793 | | M4 S/C SPRING WASHER | 19 | 19 | 19 |
| 54 | C08028 | | M3 PLAIN WASHER | 2 | 2 | 2 |
| 55 | C10747 | | M3 S/C SPRING WASHER | 4 | 4 | 4 |
| 56 | C06266 | | M4 FULL NUT | 15 | 15 | 15 |
| 57 | C12039 | | RTV | A/R | A/R | A/R |

| ITEM | PART No. | DRG No. | DESCRIPTION | QTY | 240V | 115V |
|------|----------|---------|-------------------------|-----|------|------|
| 1 | C26679 | | CHASSIS PLATE S/ASSY | 1 | 1 | 1 |
| 2 | C25012 | | FAN SPLASH COVER S/ASSY | 2 | 2 | 2 |
| 3 | C26824 | | PSU ENCLOSURE DRILLING | 1 | 1 | 1 |
| 4 | C24687 | | SPLASH COVER PILLAR | 2 | 2 | 2 |
| 5 | C17223 | | DIN RAIL | 1 | 1 | 1 |
| 6 | C26622 | | PSU | 1 | 1 | 1 |
| 7 | C27127 | | FILTER | 1 | 1 | 1 |
| 8 | C23277 | | HEATER | 1 | 1 | 1 |
| 9 | C24889 | | THERMAL SWITCH | 1 | 1 | 1 |
| 10 | C16930 | | FAN 240V | 2 | 2 | 2 |
| 11 | C16931 | | FAN 115V | 2 | 2 | 2 |
| 12 | C25013 | | FAN COVER | 4 | 4 | 4 |
| 13 | C24118 | | FUSE | 1 | 1 | 1 |
| 14 | C24021 | | FUSEHOLDER | 1 | 1 | 1 |
| 15 | C15450 | | M25 CABLE GLAND | 1 | 1 | 1 |
| 16 | C10158 | | M20 CABLE GLAND | 1 | 1 | 1 |
| 17 | C14703 | | RED BUTT CONNECTOR | 2 | 2 | 2 |
| 18 | C15828 | | RED SHROUDED CRIMP | 6 | 6 | 6 |
| 19 | C09299 | | M4 RED EYELET | 5 | 5 | 5 |
| 20 | C22701 | | M6 YELLOW EYELET | 2 | 2 | 2 |
| 21 | C02185 | | M5 YELLOW EYELET | 2 | 2 | 2 |
| 22 | C10861 | | H/C TERMINAL | 2 | 2 | 2 |
| 23 | C11175 | | H/C SPACER | 3 | 3 | 3 |
| 24 | C10469 | | H/C COVER | 1 | 1 | 1 |
| 25 | C14400 | | TERMINAL | 5 | 5 | 5 |
| 26 | C15411 | | TERMINAL MARKERS | 10 | 10 | 10 |
| 27 | C14139 | | END COVER | 1 | 1 | 1 |
| 28 | C14379 | | EARTH TERMINAL | 1 | 1 | 1 |

| ITEM | PART No. | DRG No. | DESCRIPTION | QTY | 240V | 115V |
|------|----------|---------|-------------|-----|------|------|
| 8 | C13 | | | 1 | 1 | 1 |
| 12 | C45 | | | 2 | 2 | 2 |
| 13 | C14 | | | 1 | 1 | 1 |
| 14 | C17 | | | 1 | 1 | 1 |
| 15 | C53 | | | 2 | 2 | 2 |
| 16 | C56 | | | 3 | 3 | 3 |
| 17 | C53 | | | 2 | 2 | 2 |
| 18 | C53 | | | 2 | 2 | 2 |
| 19 | C53 | | | 2 | 2 | 2 |
| 20 | C53 | | | 2 | 2 | 2 |
| 21 | C43 | | | 2 | 2 | 2 |
| 22 | C50 | | | 2 | 2 | 2 |
| 23 | C50 | | | 2 | 2 | 2 |
| 24 | C50 | | | 2 | 2 | 2 |
| 25 | C50 | | | 2 | 2 | 2 |
| 26 | C50 | | | 2 | 2 | 2 |
| 27 | C50 | | | 2 | 2 | 2 |
| 28 | C50 | | | 2 | 2 | 2 |
| 29 | C50 | | | 2 | 2 | 2 |
| 30 | C50 | | | 2 | 2 | 2 |
| 31 | C50 | | | 2 | 2 | 2 |
| 32 | C50 | | | 2 | 2 | 2 |
| 33 | C50 | | | 2 | 2 | 2 |
| 34 | C50 | | | 2 | 2 | 2 |
| 35 | C50 | | | 2 | 2 | 2 |
| 36 | C50 | | | 2 | 2 | 2 |
| 37 | C50 | | | 2 | 2 | 2 |
| 38 | C50 | | | 2 | 2 | 2 |
| 39 | C50 | | | 2 | 2 | 2 |
| 40 | C50 | | | 2 | 2 | 2 |

10 - Spare Parts List

The following spare parts can be ordered directly from the manufacturer:

Searchlight Spares

| Part Number | Description |
|-------------|------------------------------|
| C26622-00 | Power Supply Unit |
| C26623-00 | Igniter |
| C27127-00 | PSU Filter |
| C16930-00 | Fan 240v (PSU & Searchlight) |
| C16931-00 | Fan 115v (PSU & Searchlight) |
| C24889-00 | Thermal Switch |
| D21229 | 1Kw Xenon Lamp |
| C08919-00 | Front glass |
| C22011-00 | Front glass gasket |
| C27288-00 | Heater |
| C06020-00 | Reflector |
| C20281-00 | Bellows |
| C13544-37 | Cathode (Negative) adaptor |
| C24706-00 | Focus Motor |
| C15459-00 | Bearing |

Motor Gearbox Spares

| | |
|-----------|-----------------------------|
| C27288-00 | Heater |
| C27308-01 | Pan Motor Sub Assembly |
| C27157-00 | Tilt Motor |
| C22380-00 | Micro switch no lever |
| C22382-00 | Micro switch with lever |
| C27556-00 | 24v Power Supply Unit |
| C27187-01 | Speed Controller PCB |
| C22381-00 | Pedestal Top Sealing Gasket |
| C26441-00 | Pedestal Cover Gasket |

Joystick Panel Spares

| | |
|-----------|-------------------------|
| C26537-00 | Joystick |
| C27268-00 | Joystick Controller PCB |

In order to prolong the life and performance of your product, we recommend that you only specify Francis Searchlights spare parts. This will ensure that any warranties on your equipment will not be invalidated.

When ordering spare parts please contact the Sales Department at Francis Searchlights Limited. Please quote searchlight model and serial number at all times. This will enable a fast response to your spares' requirements.