



APPLICATION

The FRANCIS FR Premium range of searchlights incorporate the design features required to successfully operate searchlights in the most demanding product operating environments on land and sea.

These units are particularly suitable for use on patrol craft, custom vessels and general marine applications.

SPECIFICATION

- Toughened super clear Optiwhite front glass.
- Parabolic glass reflector
- Constructed from marine grade materials and fixings
- Powder coated and stove enamel paint finish
- Pan rotation 450°
- Deck/Deck Ped Tilt elevation control +40° to -40°.
- Cabin/Cabin Ped Tilt elevation control +30° to -40°.
- Optional Heater fitted in barrel
- Operational temp -50°
- Tungsten halogen lamp
- Light shield to prevent unwanted glare & stray light
- External lamp focus, 2° spot to 15° flood.
- Sealing – IP66 Searchlight
- Searchlight weight Deck 9.8kgs, Deck Ped 14.9Kg, Cabin 12.20Kgs, Cabin Ped 17.10Kgs
- Special B1/2 & C2 dimensions available on request

VAC	Lamp life	Range @ 1 Lux	PBCP X 1000	Div	Watts	Lamp No
12v	2000 hrs	643m	414	2°	100w	D9848
24v	300 hrs	784m	614	2°	150w	D14795
24v	2000 hrs	910m	828	2°	250w	D4695
24v	300 hrs	1095m	1200	2°	250w	D9851
120v	75 hrs	912m	832	4.9°	300w	D16883
230v	75 hrs	888m	790	4.9°	300w	D16841

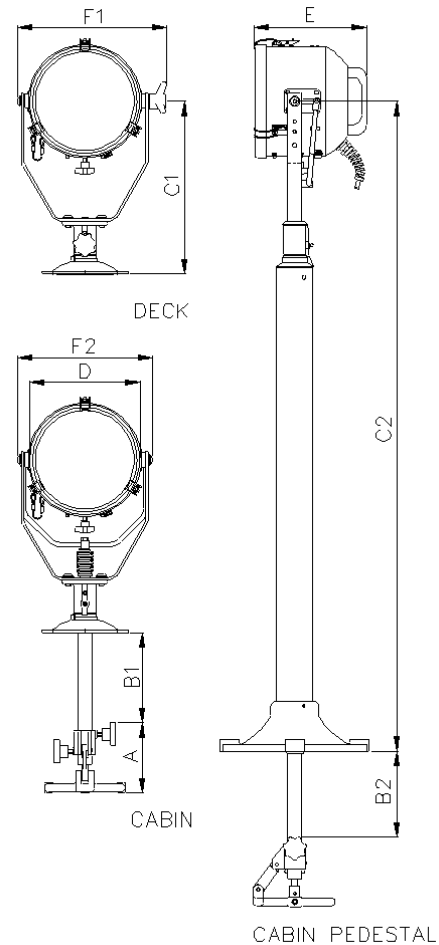

ALL DIMENSIONS IN MILLIMETRES

Base fixing details:

Deck & Cabin 3 holes Ø11.0 equi-spaced on a 154 PCD
Deck Ped & Cabin Ped 4 holes Ø14.5 equi-spaced on a 270 PCD,

Cabin & Cabin Ped Central Hole Ø40

Part Numbers

Type	Supply	Part No
FR230D Deck	12/24v	A2808
FR230C Cabin	12/24v	A2810
FR230DP Deck Ped	12/24v	A2807
FR230CP Cabin Ped	12/24v	A2809
FR230D Deck	110/240v	A2897
FR230C Cabin	110/240v	A2902
FR230DP Deck Ped	110/240v	A2904
FR230CP Cabin Ped	110/240v	A2309

Dimensions

A	B1	B2	C1	C2	D	E	F1	F2
146	188	179	361	1355	230	235	311	281