



APPLICATION

The Francis Bus Explorer range of variable speed Remote Controlled Searchlights incorporate the design features required to successfully operate searchlights in the most demanding product operating environments on land and sea.

Francis Searchlights have developed and improved all remote controlled searchlights across the range still further by adding full variable speed, a new modern and sleek joystick control panel, using membrane and LED technology, offering Bus Control.

The Francis bus (FBUS) is a custom communication protocol based on RS485 two-wire bi directional communication hardware. The system provides a simple bi directional link between searchlights and control panels.

The FR300RC Range Explorer is a high quality mid range compact remote control searchlight. These units are particularly suitable for use on patrol craft, custom vessels and general marine applications.

SPECIFICATION

- Tungsten Halogen light source.
- Toughened super clear Optiwhite front glass.
- Parabolic glass reflector.
- Constructed from marine grade materials and fixings.
- Light shield to prevent unwanted glare and stray light
- Powder coated and stove enamel paint finish.
- Pan rotation 365°.
- Tilt elevation control ±35°.
- Variable speed LED joystick, with auto home position.
- RS485 connectivity. Dimmable Control Panel.
- Variable Rotation Speed 1 to 60°/sec (Pan).
- Variable Elevation Speed 1 to 17°/sec (Tilt).
- Heater fitted in gearbox & optional in barrel.
- Operational temp -50°.
- Remote lamp focus fitted as standard. 2.5° spot to 10° flood.
- Sealing - IP67 Gearbox, IP66 Searchlight.
- Searchlight weight 32kgs.
- Redesigned gearbox housing, incorporating cable termination, for direct connection.

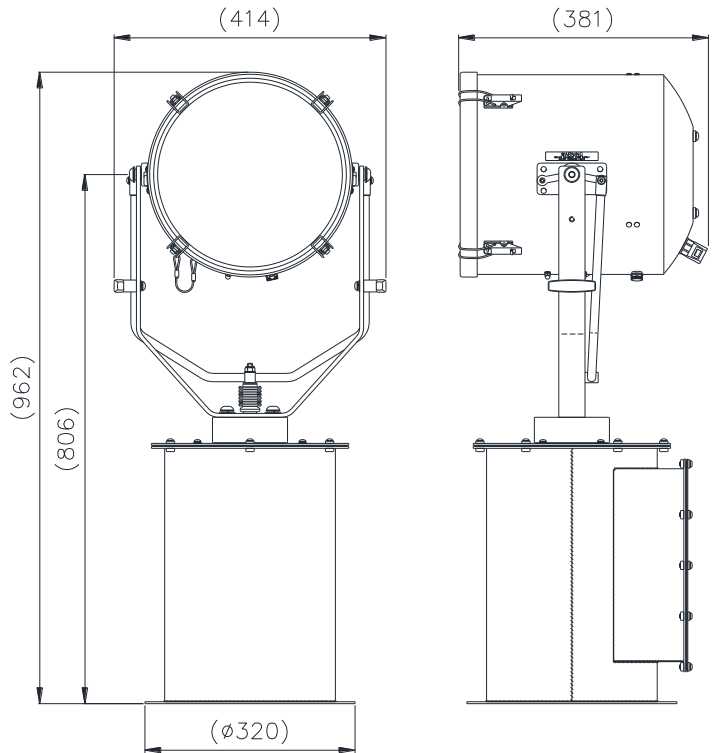

ALL DIMENSIONS IN MILLIMETRES

Base fixing details:

4 holes 12.5 Ø equi-spaced on a 290mm PCD
Joystick panel 120 x 120mm (106 x 106mm cutout)

Part Numbers

Type	Supply	Watts	Part No
FR300RC	115/230v	650-1Kw	A7125
FR300RC	24v	150-250w	A7124

Optional extras:

- Computer Control Software
- Azimuth LED Control Panel
- Master Control Panel (control up to 6 Searchlights)
- Slave Control Panels (with full control)
- Fiber Optic/TCP/IP Connections
- Flir Thermal camera

Volts	Lamp Life	Range @ 1 Lux	PBCP X 1000	Div	Watts	Lamp Part No
24v	300 hrs	1490m	2220	3°	250w	D9851
230v	750 hrs	905m	820	5°	650w	D1813
115v	750 hrs	1000m	1000	5°	1000w	D1809
230v	750 hrs	970m	940	5°	1000w	D6715