



APPLICATION

The FRANCIS FR Premium range of searchlights incorporate the design features required to successfully operate searchlights in the most demanding product operating environments on land and sea.

These units are particularly suitable for use on patrol craft, custom vessels and general marine applications.

SPECIFICATION

- Toughened super clear Optiwhite front glass.
- Parabolic glass reflector
- Constructed from marine grade materials and fixings
- Powder coated and stove enamel paint finish.
- Pan rotation 450°
- Deck/Deck Ped Tilt elevation control +40° to -40°.
- Cabin/Cabin Ped Tilt elevation control +30° to -40°
- Optional Heater fitted in barrel
- Operational temp -50°
- Tungsten halogen lamp
- Light shield to prevent unwanted glare & stray light
- External lamp focus, 5° spot to 15° flood.
- Sealing – IP66 Searchlight
- Searchlight weight Deck 40kgs, Deck Ped 42.9kg, Cabin 50Kgs, Cabin Ped 73.6Kgs
- Special B1/2 & C2 dimensions available on request

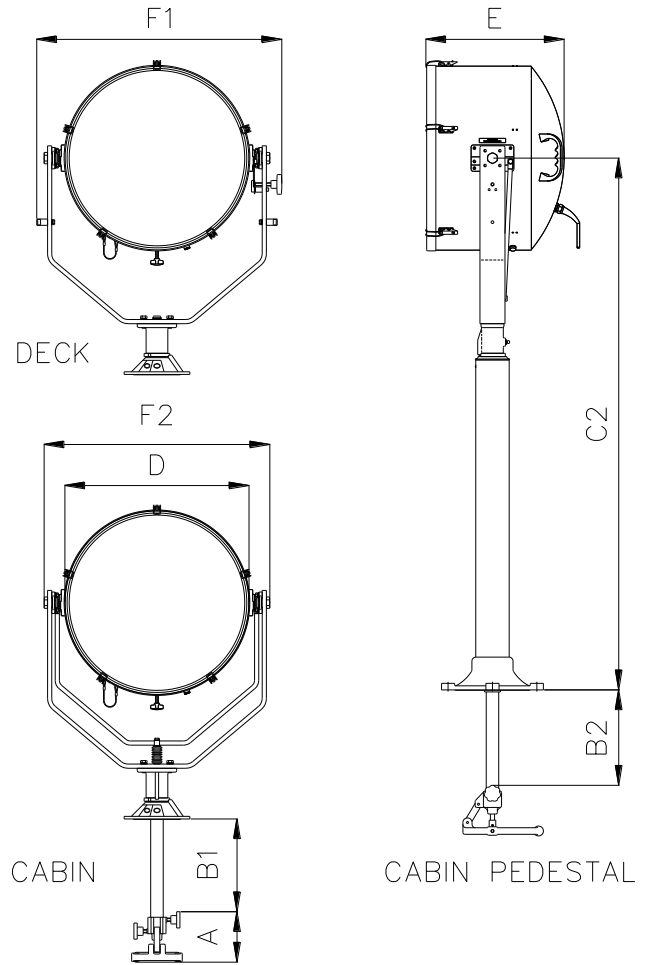

ALL DIMENSIONS IN MILLIMETRES

Base fixing details:
Deck & Cabin 3 holes Ø11.0 equi-spaced on a 174 PCD
Deck Ped & Cabin Ped 4 holes Ø14.5 equi-spaced on a 270 PCD,
Cabin & Cabin Ped Central Hole Ø52

Part Numbers

Type	Supply	Part No	1kw	2kw
FR560D Deck	110/240v	A2886	A2886	A2890
FR560C Cabin	110/240v	A2888	A2888	A2892
FR560DP Deck Ped	110/240v	A2885	A2885	A2889
FR560CP Cabin Ped	110/240v	A2887	A2887	A2891

Dimensions

A	B1	B2	C1	C2	D	E	F1	F2
154	283	291	659	1620	560	452	746	686

VAC	Lamp life	Range @ 1 Lux	PBCP X 1000	Div	Watts	Lamp No
115v	750 hrs	1550m	2450	5°	1000w	D1809
115v	400 hrs	2030	4121	5.5°	2000w	D1823
230v	750 hrs	1550m	2450	5°	1000w	D6715
230v	400 hrs	2030m	4121	5.5°	2000w	D4604
240v	400 hrs	2030m	4121	5.5°	2000w	D1839

For more information contact: