



APPLICATION

The new Francis L300RC Remote Focus Twinhead LED searchlight range, incorporates Thermal imaging camera function, with a superior range of variable speed Remote Controlled Searchlights. The design, functionality and build quality, enable it to operate in the most demanding operating environments on land and sea. Integrated Flir Thermal camera, offering exceptional night vision capability Using the highest grade of the world class Osram LED, this range offers a high power output with low power consumption. Using a series of precision made glass lenses to optimize and collimate the light output, to achieve a greater range and output. The high power LED Chip has 20,000 hour life.

As with all Francis products, the construction is robust and of the highest quality. To dissipate the heat generated by the high power LED, there has been a great focus on thermal management, fitting an internal heatsink, cooled by internal fans, maintaining the heatsink at the required temperature, to optimise the chip output.

Francis Searchlights have developed and improved all remote controlled searchlights across the range still further by adding full variable speed, a new modern and sleek joystick control panel, using membrane and LED technology, offering Bus Control, auto home position setting, all at no extra cost, with Optional Controls available on request.

SPECIFICATION

- Toughened super clear Optiwhite front glass.
- 20,000 lamp life hours
- Precision made glass lenses.
- Constructed from marine grade materials and fixings.
- Powder coated and stove enamel paint finish
- Pan rotation 385°.
- Tilt elevation control $\pm 35^\circ$
- Variable speed LED joystick, with auto home position.
- RS485 connectivity, Dimmable Control Panel
- Variable Rotation Speed 1 to 23°/sec (Pan).
- Variable Elevation Speed 1 to 8°/sec (Tilt).
- Heater fitted in gearbox & barrel.
- Operational temp -50°.
- Up to 45,600 Lumens.
- Colour Temp options 6000k
- Sealing - IP66 Gearbox, IP56 Searchlight, PSU IP66.
- Searchlight weight 75kgs, PSU weight 8kgs.
- Range of 1876m is based on 4° divergence
- Remote Focus fitted as standard, giving an impressive range of 4 - 10° beam divergence adjustment.

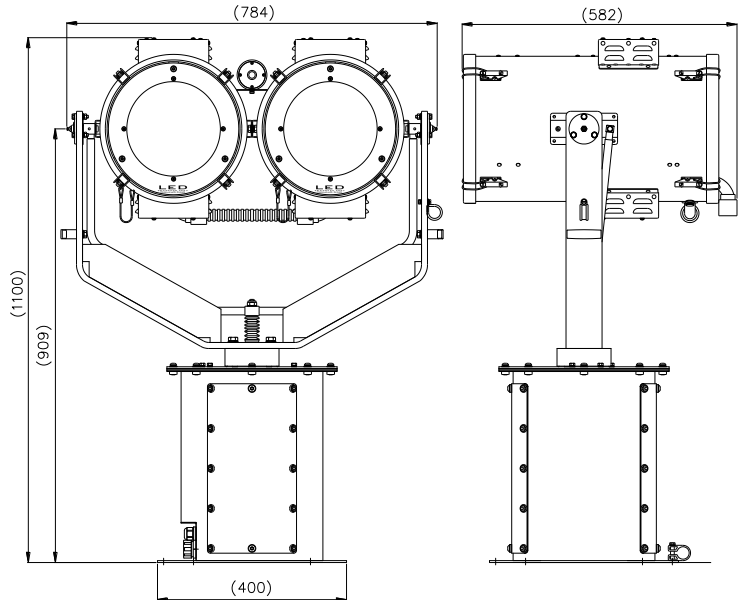

ALL DIMENSIONS IN MILLIMETRES

Base fixing details:

4 holes 12.5 \varnothing equi-spaced on a 350mm PCD
Joystick Panel 150 x 150mm (cutout 106 x 136mm)
PSU dimensions: 360 x 400 x 155mm

Part Numbers

Type	Supply	Watts	Part No
L300RC	115/230v	468w	A7203
L300RC	24v	468w	A7204

Optional Controls:

Program Record Function
Computer Control Software
Azimuth LED Control Panel
Master Control Panel (control up to 10 Searchlights)
Slave Control Panels (with full control)
Fiber Optic/TCP/IP Connections

Camera Specification:

Flir Thermal camera, image resolution 336 x 256, with 14mm lens, offering exceptional night vision capability, Field of vision 16° horizontal x 13° vertical. Detection = 600m, Recognition = 150m, Identification = 80m

VAC	Lamp life	Range @ 1 Lux	Luminous Flux	Div	Watts
115/230/24v	20,000 hrs	1876m	45,600	4-10°	468w